

An aerial photograph of a residential development during sunset. The scene shows a large green lawn in the foreground, with rows of modern houses in the middle ground. The sun is low on the horizon, creating long shadows and a warm, golden glow. A white circular graphic is overlaid on the right side of the image, containing the title and subtitle text.

Everleigh

**Residential Design
Standards and Guidelines
Precinct 9.6**

Contents

<p style="text-align: center; margin: 0;">UNDERSTANDING THE RESIDENTIAL DESIGN STANDARDS & GUIDELINES</p>	<p style="text-align: center; margin: 0;">MANDATORY COMPLIANCE ELEMENTS</p>	<p style="text-align: center; margin: 0;">OPTIONAL/RECOMMENDED ELEMENTS</p>
<p>Residential Design Standards and Guidelines 3</p> <p>How the Residential Design Standards and Guidelines Work 4</p> <p>Building @ Everleigh Portal 5</p> <p>The Approval Process 6</p>	<p>Part 1 Design & Siting Standards 8</p> <p>Approved Plan of Development – Envelope Plan and Design Criteria 8</p>	<p>Part 2 Architectural and Landscape Design Standards 10</p> <p>Minimum Building Size 10</p> <p>Roofs 10</p> <p>Façade Design 10</p> <p>External Wall Materials and Colours 11</p> <p>Driveways & Entry Paths 11</p> <p>Privacy and Cross Viewing 12</p> <p>Security and Insect Screens 12</p> <p>External Services and Waste Recycling 12</p> <p>Fences General 12</p> <p>Landscaping 13</p> <p>Construction Obligations 14</p> <p>Developer Works 14</p>
<p>.....</p> <p>Definitions 20</p> <p>.....</p>	<p>.....</p> <p>Annexure A Approved PoD – Envelope Plan 23</p> <p>Annexure B Approved PoD – Design Criteria 29</p> <p>.....</p>	<p>Part 3 Sustainable Living Guidelines 18</p> <p>Objectives 18</p> <p>Energy Consumption and Greenhouse gas-emission reduction 18</p> <p>Water Conservation and reuse 18</p> <p>Materials and Waste 19</p> <p>Smart Technology 19</p> <p>Landscaping 19</p> <p>.....</p> <p>Annexure D Landscape Design Guidelines 41</p> <p>Annexure E Retaining Wall Fact Sheet 58</p> <p>.....</p>

Residential Design Standards and Guidelines

These standards and guidelines have been prepared to assist Everleigh purchasers (and their builders/designers) to construct well designed, quality homes and to join Mirvac in creating great places for life.

The standards and guidelines are intended to help you add value to your home and protect your investment by creating an attractive streetscape.



Great design creates a welcoming and attractive streetscape. This not only improves your quality of life but establishes Everleigh as a great place to live and a place in which you will be proud to be a part of.

Street Appeal

These standards and guidelines will assist in making your home part of an attractive streetscape. This is achieved by using the right materials and colours and including some cost effective design elements to the front façade.



Fencing

Fences which are visible from the street are an important part of the streetscape. So at Everleigh we ask that these are of a higher standard and quality but for most lots this is only a short length and the balance of the fencing can be the neighbour type fence.



Landscaping

A great way to make your home unique is through landscaping. We ask that you include landscaping that will grow into an attractive low maintenance front yard that complements the parks and bushland that are a great part of Everleigh. This document provides design standards to ensure that cohesive and attractive landscaping is established.

How the Residential Design Standards and Guidelines Work

The Everleigh Residential Design Standards and Guidelines (Design Standards & Guidelines) sets out:

- **Standards** which are mandatory compliance elements; and
- **Guidelines** which are non-mandatory elements that provide further information and suggestions to improve design and quality of life.

The Design Standards and Guidelines are technical in nature and it is recommended that you speak to your builder or an Everleigh sales team representative who will be able to guide you through this process.

The Design Standards and Guidelines consists of three parts as follows:



AUTHORITY REQUIREMENTS

Design and Siting Standards

Directs customers to the Approved Plan of Development – Envelope Plan and Design Criteria documents which include the **mandatory design standards for siting your home** to the specific characteristics of your lot. These documents are available in Annexure A and B.



MIRVAC REQUIREMENTS

Architectural and Landscape Standards

Provides the **mandatory architectural and landscape design standards** to include in all homes in Everleigh which are essential to making Everleigh a place in which you will be proud to live.



GOOD PRACTICE

Sustainable Living Guidelines

Provides **suggestions** to introduce some easy ways to potentially reduce your future ongoing costs and the impact on the environment.

Alternative design solutions may be presented to the Everleigh Design Committee and will be assessed on individual architectural merit. The Design Committee acting reasonably may approve alternative design solutions where it is considered that they achieve the overall intent and desired outcomes of the Design Standards & Guidelines.

Building @ Everleigh Portal

We understand that keeping track of all this information can be a challenge and have established a web portal to assist.

The **Building @ Everleigh Portal** is a one stop shop for information relating to your lot, including but not limited to the following:

- Residential Design Standards & Guidelines
- Fact Sheets and Manuals
- Approved Plan of Development – Envelope Plan
- Approved Plan of Development – Design Criteria
- Survey Plans
- Disclosure Plans
- Civil Design Drawings
- Services Location Plan
- As Constructed Drawings
- Compaction Reports
- Acoustic Report
- Bushfire Management Plans

The information available in the **Building @ Everleigh Portal** will help you and your builder make informed decisions regarding the design of your home.

The **Building @ Everleigh Portal** is accessible via the Everleigh website or speak to an Everleigh sales representative.



The Approval Process

You will need both the Design Approval from the Everleigh Design Committee (Design Committee) and Building Approval from Logan City Council (Council)/ building certifier before you can commence construction.

Mirvac has developed a streamlined process based on previous experience to ensure that you can start building your home and garden as soon as possible.

HOT TIP!

The Design Committee often receives an influx of applications at the time of settlement. To avoid any potential delays to starting the build on your lot, we recommend that your builder submits your application as early as possible to give you a head start on the assessment process.

YOUR STEPS

HOT TIP!

It may seem daunting but often your builder has plenty of experience with this process.

Design

Your builder will work with you to design your home to comply with this document.

Proceed to Step 2 once you're happy with your design and your builder has drawn up the consolidated set of plans.

STEP
1

HOT TIP!

Please ensure that your builder attaches all the required documentation listed in the Covenant Application Form as part of the submission.

Submission

Your builder submits your house plans, colour schedules, landscape plans and proof of covenant payment (refer to Step 3) to the Design Committee via the Building @ Everleigh Portal.

STEP
2

HOT TIP!

*Be sure to include the proof of bond payment as part of your covenant application to avoid a delay in the assessment and approval process. **The bond will be returned after the final inspection (refer Step 9).***

Covenant Bond Payment

Your fully refundable **Covenant Bond** is required to be deposited to the following account to be held in trust.

HWL Ebsworth Lawyers Law Practice Trust Account

BSB: **034-003** Acc Number: **246634**

Description: **"Surname & Lot Number" – Covenant Bond**

Amount: **\$1000**

STEP
3

OUR STEPS

STEP
4

Assessment

The Design Committee will assess your submission for compliance with the Design Standards & Guidelines. During this process we will work with you and your builder if anything needs amendment. In some cases, plans may need to be resubmitted. This process normally takes 2 weeks if all information is provided.

STEP

5

Design Approval

The Design Committee will issue an approval when your submission has been assessed as complying with the Design Standards & Guidelines. Your stamped approved plans will be provided to you and your builder via the **Building @ Everleigh Portal**.

HOT TIP!

Please take care to note any comments on your Everleigh Design Committee stamped approved plans to ensure that all conditions of the Design Committee approval are addressed.

Building Approval

Once Design Committee approval has been issued, your builder can then make an application to your accredited building certifier/Council for the **statutory Building Approval**.

STEP
6

Construction

Please ensure that your lot is **properly maintained** to be free of excessive weeds, rubbish or garbage prior to and during the construction phase of your home. This will ensure that the land is safe at all times.

STEP
7

Call for Inspection

Once your house and landscaping is complete, please touch base with us via the **Building @ Everleigh Portal** to **organise your final inspection**.

STEP
8

STEP
9

Inspection & Refund

The covenant bond will then be refunded once **final compliance approval** is issued by the Design Committee and the **return bond form** is completed on the **Building @ Everleigh Portal**.

Design & Siting Standards

Approved Plan of Development — Envelope Plan and Design Criteria

We recommend that you speak with your builder or an Everleigh Sales Team representative who will be able to guide you through the Approved Plan of Development – Envelope Plan and the Approved Plan of Development – Design Criteria (PoD documents) and how these relate to your specific lot.

The Approved PoD documents are available in Annexure A and B.

The Design and Siting Standards (Part 1) which includes the approved PoD documents should also be read with the Architectural and Landscape Design Standards (Part 2).

Where compliance with any particular design standard in Part 2 results in non-compliance with Part 1, then the design standard for Part 1 takes precedence. In all other instances, the design standards in Part 2 take precedence.

Provided overleaf is a simple flow chart with instructions on how to navigate the PoD documents should you wish to review and understand these provisions yourself.

Figure A Instructions to navigate the Approved Plan of Development Documents

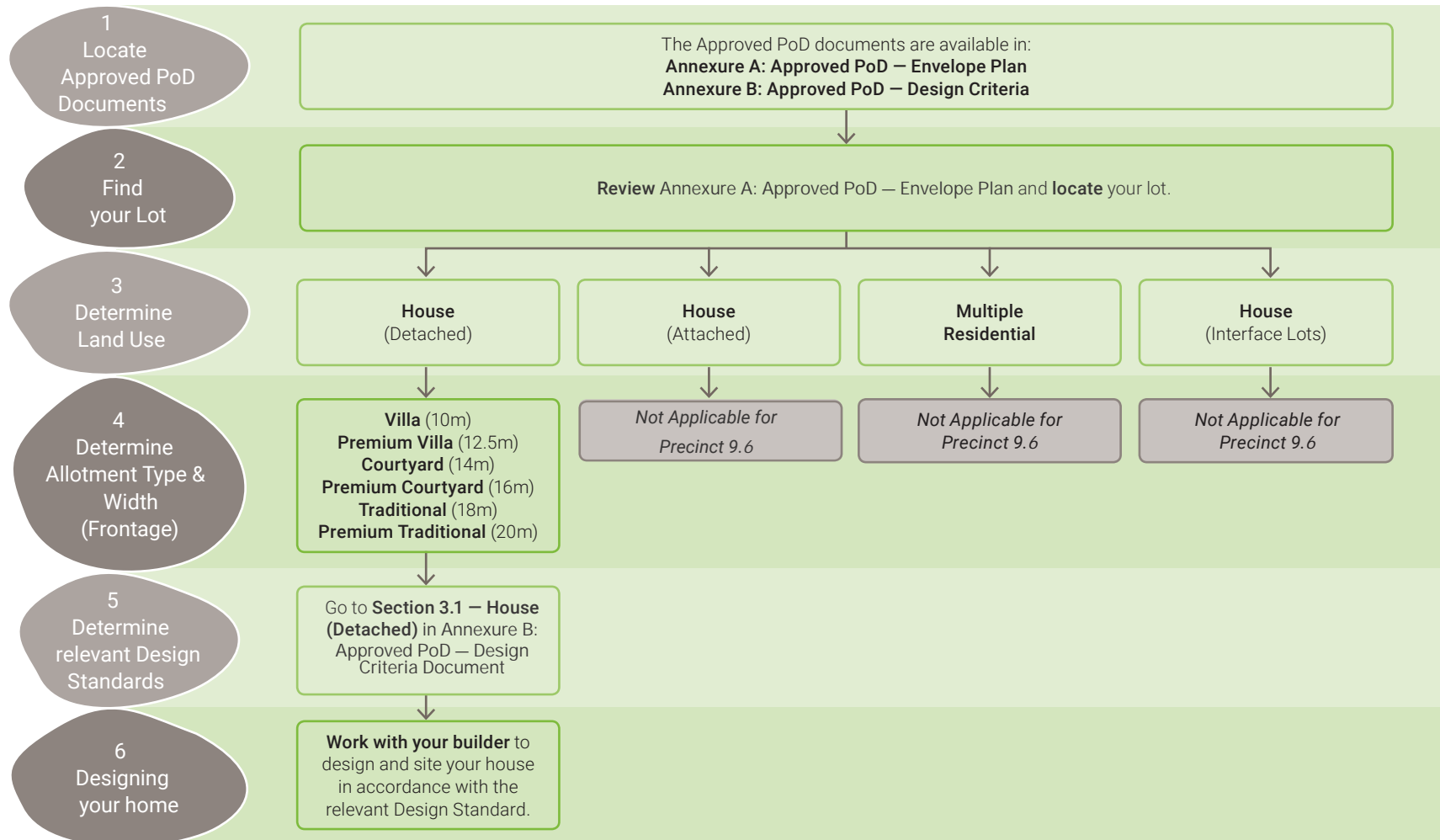

Architectural and Landscape Design Standards

MINIMUM BUILDING SIZE

- For lots with only one street frontage, the minimum width of your home is 75% of the primary street frontage width, measured to the outside of walls.

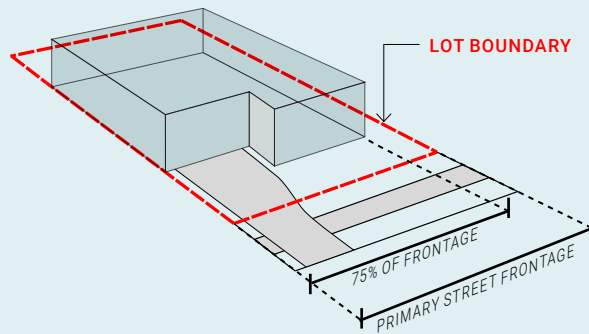

- For corner lots the minimum width and length is 65% of the respective frontage.

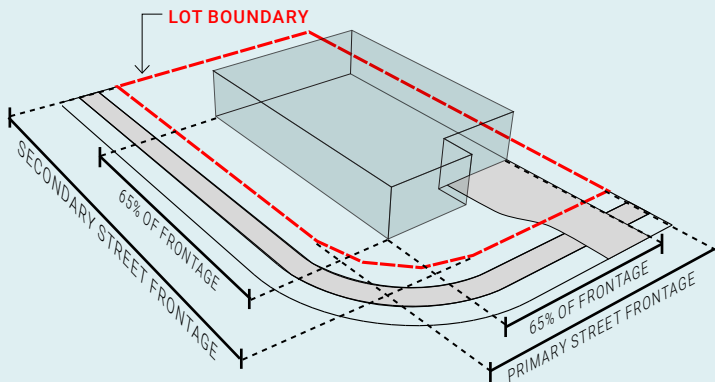

ROOFS

- 40 degrees is the maximum pitch for traditional hip and gable roofs.
- Skillion roofs should be proportional to the main body of the home and roof pitches should generally be between 7.5 – 15 degrees.



- All single storey houses are to have a minimum of 450mm eaves to all publicly visible façades.
- All double storey houses are to have a minimum of 450mm eaves to all publicly visible façades on ground level, and a minimum of 450mm eaves must be provided to all elevations on the upper storey. Variations on this (e.g. inclusion of a parapet) may be approved on merit if it achieves a positive addition to the façade of your home.
- Your roof materials are limited to:
 - Corrugated pre-finished metal sheets (e.g. Colorbond).
 - Roof Tiles.
 - Your roof colour must be of a muted / earthy tone (refer to colour palette below for guidance). Harsh colours such as blue, red and black are not permitted.

Colorbond references:



HOT TIP!

For more information, please visit the [Building @ Everleigh Portal](#).

FAÇADE DESIGN

Primary Street Façade Design

- The residential character of your home must be of a contemporary architectural aesthetic or design. It should reflect the characteristics of Everleigh, embracing the natural bushlands and open spaces, with sympathetic colour tones and material palette. No federation or colonial design elements should be included in the design.
- The façade must have variation in the elevation with **at least one substantial projecting feature element** such as a portico, verandah or feature wall.
- Any entrance portico must be proportional to the façade of the building and is to be a minimum of 4m² (including eave overhangs) and 1.5m deep.
- At least 1 habitable room must address the primary street frontage.

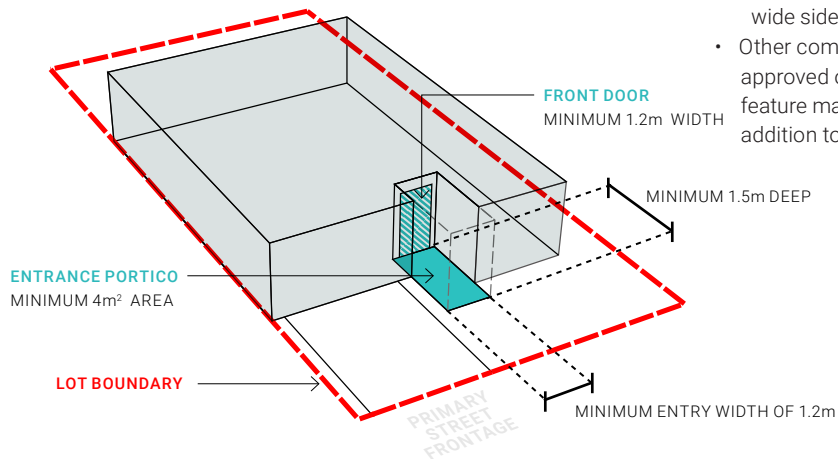

- Similar homes with similar façades are not allowed on adjoining lots.
- Obscure windows or windows to toilets and bathrooms should not front the primary street, unless aesthetically screened.
- Walls over 9m in length without windows or articulation are not permitted.
- No garden sheds, air conditioning condensers or clothes lines, etc. can be located between the primary street façade and boundary.

Front Entry Door

- Your home's front door must be well defined and/or visible from the primary street.
- The entry door must be:
 - nominal 1200mm wide with minimum 20% glazing; or
 - nominal 1000mm wide combined with a minimum 200mm wide sidelight
- Other combinations on smaller frontages (<12.5m) may be approved on merit subject to the inclusion of additional feature material being incorporated to achieve a positive addition to the façade of your home.

Garages

- Minimum two car (side by side) internal garage must be provided for lots with frontages of 12.5m or greater.
- Garages must be integrated into the main building and are to be setback 1m behind the front wall of the main building.

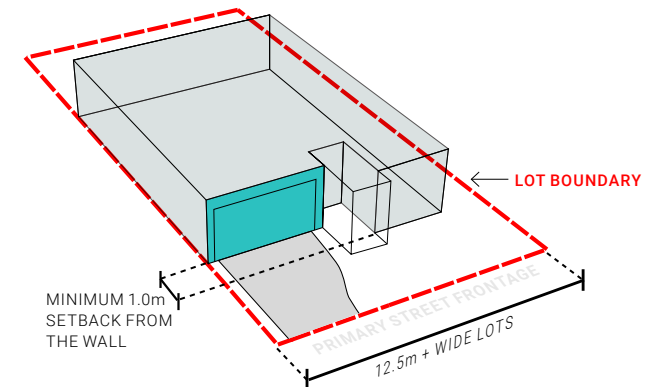
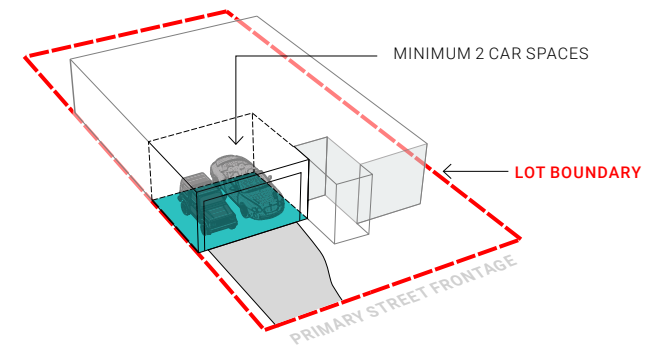

Secondary Street Façade Design

- If your home is on a corner lot, it must be designed to address all streets.
- It must have variation in the secondary street façade with at least one substantial projecting feature element such as a portico, verandah or feature wall.
- Walls over 9m in length without windows or articulation are not permitted.
- At least 1 habitable room should address the secondary street frontage.
- No garden sheds, air conditioning condensers or clothes lines, etc. can be located between the secondary street façade and boundary unless they are screened from view from a Public Area by approved screens or fences.

Glazing to Public Areas

- All façades (excluding the garage door) are to include glazing for a minimum 10% of the façade area to provide surveillance, interest and variation.
- Sliding windows under 1200mm width are not permitted.
- Reflective glass is not permitted.
- Temporary window treatments or vertical blinds are not permitted.

LETTER BOXES

- The letter box must be complementary to the modern aesthetics of the primary building and be constructed using materials such as stone and masonry.
- The letter box must be installed prior to the occupation of the main building.

EXTERNAL WALL MATERIALS AND COLOURS

- To give a sense of variety and interest, a mix of materials or colours must be used to all walls of your home facing a street or park frontage.
- A minimum of 2 and a maximum of 3 variations of colour and/or materials (excluding windows, doors and garage doors) must be incorporated.
- Colour and/or material change should comprise a minimum 10% of façade wall area.

External Wall Materials

- Face brickwork or split-face block work is not permitted on primary street, secondary street or public open space façades except as a limited feature only.
- Finishes to the Primary Street and or Secondary Street Façade must return back around the other walls and extend back 1m or wherever the side fence meets the house, whichever is the greater.
- Finishes to any non-feature masonry on primary street and secondary street façade must be solid render not 'bag and painting'.
- Double or 1.5 height face brick is not permitted anywhere.
- Finishes to any non-feature masonry on public open space façades may be 'bag and painting' and the finish used on this façade must also be used on the adjoining side and/or rear walls.
- Second hand materials are not permitted unless they are used as highlight architectural elements.



For more information, please visit the
Building @ Everleigh Portal.

External Wall Colours

- Your colour scheme must be primarily muted tones, but limited and controlled feature highlight colours may be approved.
- Each application is to be accompanied by an External Colour Schedule clearly nominating the location and extent of colours and materials.

DRIVEWAYS & ENTRY PATHS

- Acceptable materials for your driveway include coloured concrete, exposed aggregate concrete and pavers on a concrete base slab. Stencil or painted finish are also accepted. These must compliment the external colour scheme of your home.
- The main pedestrian entry path to your home must be from the primary street frontage and must be constructed from a permanent hard surface such as coloured concrete, exposed aggregate, natural stone or concrete pavers. Pebble or decorative gravel are not permitted as materials for the main entry path to your home but can be used in conjunction with the permanent hard surface i.e. around pavers of stepping stones.
- Side paths must be constructed from similar materials to the main entry path or decorative gravel on compacted road base. Material selection must reflect and integrate with the surrounding landscape.
- It is important that you ensure your builder complies with Council's approval requirements for your driveway as Council may require you to remove it and reconstruct it if it is not constructed correctly.

PRIVACY AND CROSS VIEWING

Privacy between your home and your neighbours' homes is to be achieved by one or more of the following measures:

- Obscure glazing to all bathrooms and toilets.
- 1.7m high sill levels above floor level.
- External screens.
- 1.8m high dividing fence for ground floor windows.
- Where a direct view from a verandah or deck exists into the Private Open Space of an adjoining home, the outlook must be screened by privacy screens that have openings that make it not more than 25% transparent.

SECURITY AND INSECT SCREENS

- The style of any screen visible from a Public Area must be of a simple profile. **Hexagonal, diamond grill or ornate historical styles are not permitted.**
- Frames and screens must match the colour of the door or window frames or be dark grey or black in order to reduce their visual impact.
- Security shutters or security blinds over windows are not permitted if visible from a Public Area.

EXTERNAL SERVICES AND WASTE RECYCLING

- If you have a rainwater tank it must be located away from or screened from view from all Public Areas.
- Meter boxes must be painted to match the wall colour.
- TV aerials are to be installed inside the roof cavity or designed and located so that they are not visible from Public Areas
- Radio masts or satellite dishes are to be designed and located so that they are not visible from Public Areas.
- Storage tanks for solar hot water systems, roof and wall mounted air conditioning units, clothes drying facilities and service yards are not to be visible from Public Areas.
- **Garbage bin pads are mandatory and are to be located so that they are not visible from Public Areas.**

CONSTRUCTION OBLIGATIONS

- Your building site must be clean and safe at all times.
- Your builder must provide a skip bin or enclosure on site to contain rubbish for the duration of the construction period.
- Bins and site facilities must be clear of all neighbouring properties, roads, footpaths, reserves and all other Public Areas at all times.

DEVELOPER WORKS

- Where the Developer has constructed a fence, entry statement or retaining wall, it is to be maintained by the owner to the standard to which it was constructed.
- The road and verge in front of your lot including the concrete footpath and services such as water meters, telecommunication boxes, **street trees**, stormwater drains, manholes, and electrical pillars are assets owned by Council or service authorities. They have been constructed to the required standards and Council and other service authorities have recorded them as correctly constructed prior to your house building commencing.
- These assets cannot be altered, including changing the ground levels, without the correct approval from Council. Mirvac inspects these assets at completion of your home to ensure no damage. Any damage caused during construction of a dwelling to any estate infrastructure (e.g. kerbs, grassed verges, street trees, bollards, etc.) is to be repaired by the owner to the standard to which it was constructed.

HOT TIP!

Make sure that any damage to these assets are repaired before the final inspection. This will avoid a delay in refunding your covenant bond.

LANDSCAPING

- The landscaping to areas of your lot visible from Public Areas must be approved by the Design Committee.
- Planted garden beds must be provided to a minimum of 50% of the available soft landscaping area forward of the building line on the primary street frontage and 20% of the available soft landscaping area forward of the building line on the secondary street frontage (if applicable), with high quality turf installed to the remainder of soft landscaping areas.
- Generally, a 50/50 ratio of shrubs to ground covers will establish an appealing look.
- A minimum of two advanced trees (minimum size of 45L stock and 1.8m tall at the time of planting) must be provided to the landscape areas between your house and the verge.
- Gardens are to be edged with concrete, galvanized steel, masonry or rectangular shaped treated timber, but not round timber, logs or plastic edging.
- Garden edges with a height exceeding 200mm are considered to be a retaining wall, therefore must be constructed according to the design requirements of a retaining wall.

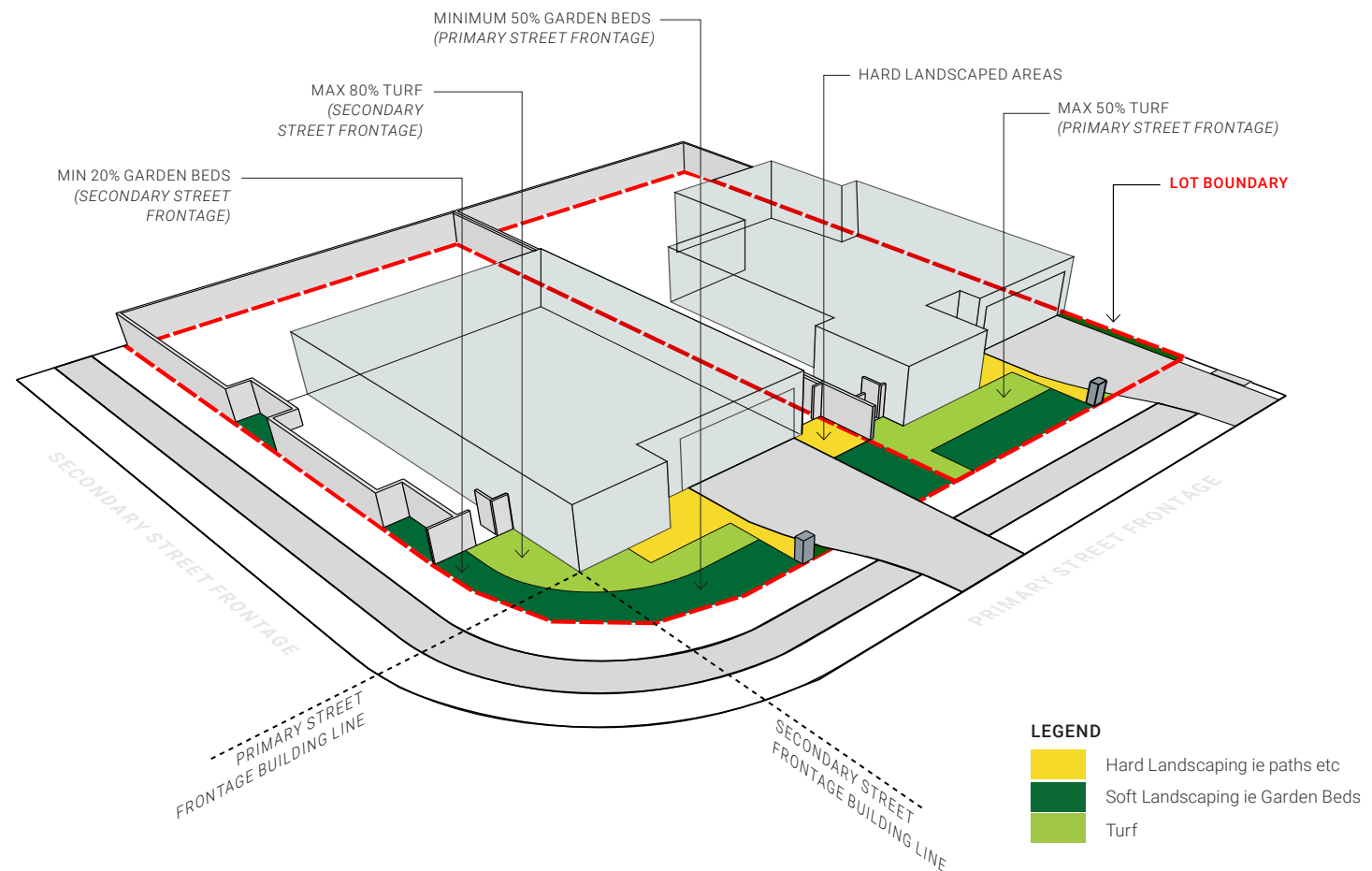

HOT TIP!

For more information, please visit the **Building @ Everleigh Portal**.

Retaining Walls

- A retaining wall is defined as any retaining structure higher than 200mm.
- All retaining walls must be constructed as part of the construction of your home.
- Retaining walls must be tiered 1m vertical and 1m horizontal where forward of the building line to any street, park or lane and visible from Public Areas and must be constructed to match the developer's specification or materials such as stone, masonry, steel or quality hardwood timber. The horizontal section is to comprise a planting zone to soften the visual impact of the retaining wall.

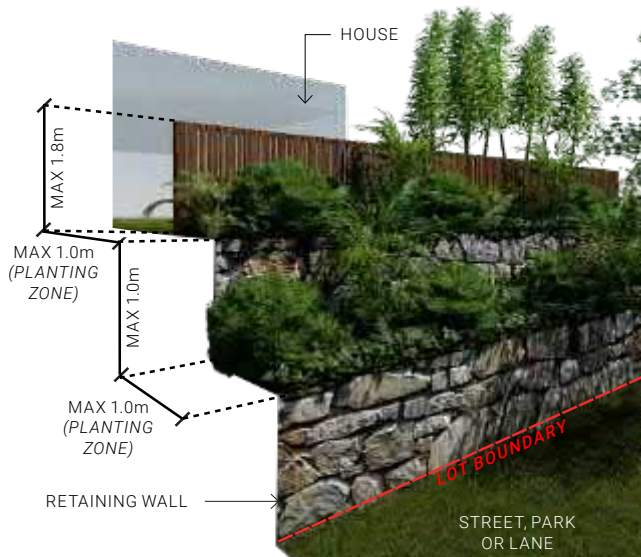

- For sloping lots and where a built to boundary wall is permitted, this wall must be projected to at least 150mm below the likely pad level of the adjacent block. The pad level can be assumed to be the average of the four corners of the adjacent block using the As Built levels. The build down of the built to boundary wall must be in a material consistent with the visible section of the wall immediately above it.

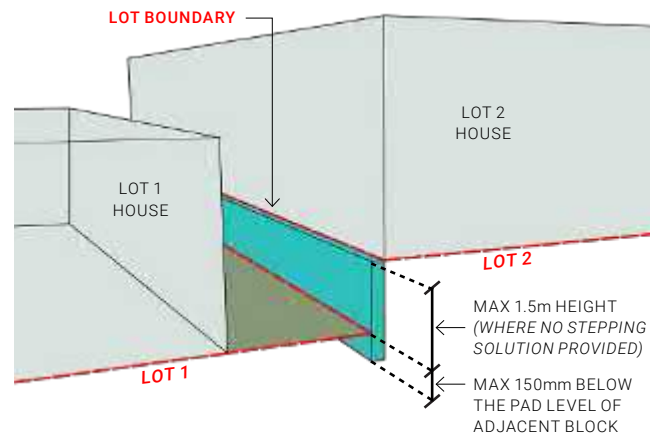

- Retaining wall construction must include a suitable drainage system to deliver sub-surface water below the wall to the local storm water system.
- Retaining walls may need to be certified by a Registered Professional Engineer. You are required to meet the Local Authorities requirements with regard to this matter.
- Please refer to the Retaining Wall Fact Sheet and WRB Retaining Wall Warranty in Annexure E for further detail.

Sheds

- Must be located behind the front building line and screened from view from a Public Area.
- Must be painted or stained to suit the colour scheme of the home. Reflective materials are not permitted.
- Must be less than 12m².
- Must be less than 2.1m in height.

FENCES GENERAL

- All fences to your lot must be approved by the Design Committee.
- **Only fence types shown in Annexure C are allowed.** No other materials such as bamboo or colorbond are allowed.
- Fences constructed by Mirvac on any lots cannot be removed or altered without written permission from Mirvac. Any damage to these fences must be repaired to the original standard by the land owner(s).
- Fences visible from Public Areas must be maintained on an ongoing basis including recoating with timber treatment if detailed as part of the fence type.
- All lots are required to have side & back fences.
- **Fences are not permitted along road frontages forward of the building line.**

Fencing facing the Primary Street

- Must be Feature Fence Type A or B.
- Maximum 1.8m in height.
- Must be located a minimum of 1m behind the adjoining front façade wall.

Fencing facing the Secondary Street or Pedestrian Links

- Must be Feature Fence Type A or B.
- Maximum 1.8m in height.
- Must not extend past the façade line of the other street frontage.
- Fences more than 10m in length must be articulated further from the boundary, to allow for planting alcoves, by a minimum 0.75m alignment variation over a minimum length of 2m.
- Appropriate landscaping must be included within the planting alcoves.

Fencing to Side and Rear Boundaries Not on a Public Open Space Boundary

- Must be a Neighbour Fence Type 1 or 2 (except as detailed below).
- Maximum 1.8m in height.
- Must not be visible from Public Areas.
- The portion of the side or rear fence which protrudes forward of the fence facing the Primary or secondary street must not extend past the adjoining front façade wall and must be the same type as the Primary or secondary street fence.

Fencing to Public Open Space Boundaries

- Must be Feature Fence Type A or B.
- Maximum 1.8m in height.
- Where fencing is required to the top of retaining walls on a street or public open space boundary and where the combined height will be greater than 1.8m then the fence must be tiered / setback 1m from the back of the retaining wall to allow for planting in front of the fence to soften the visual impact.

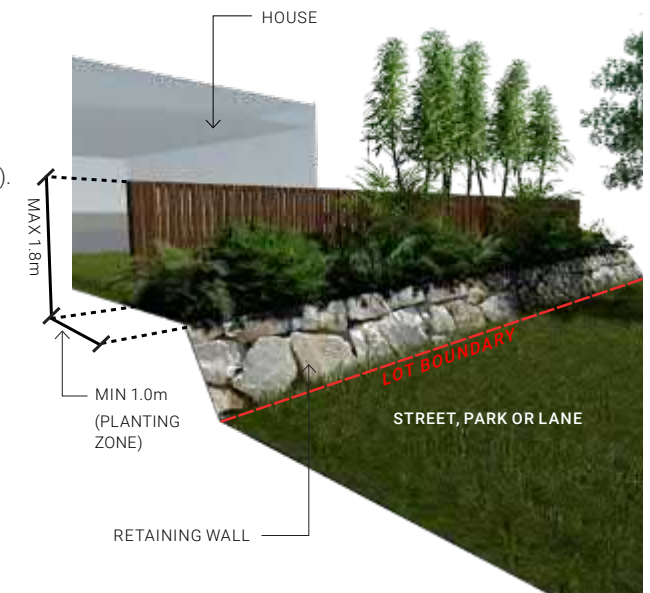



For more information, please visit the **Building @ Everleigh Portal**.

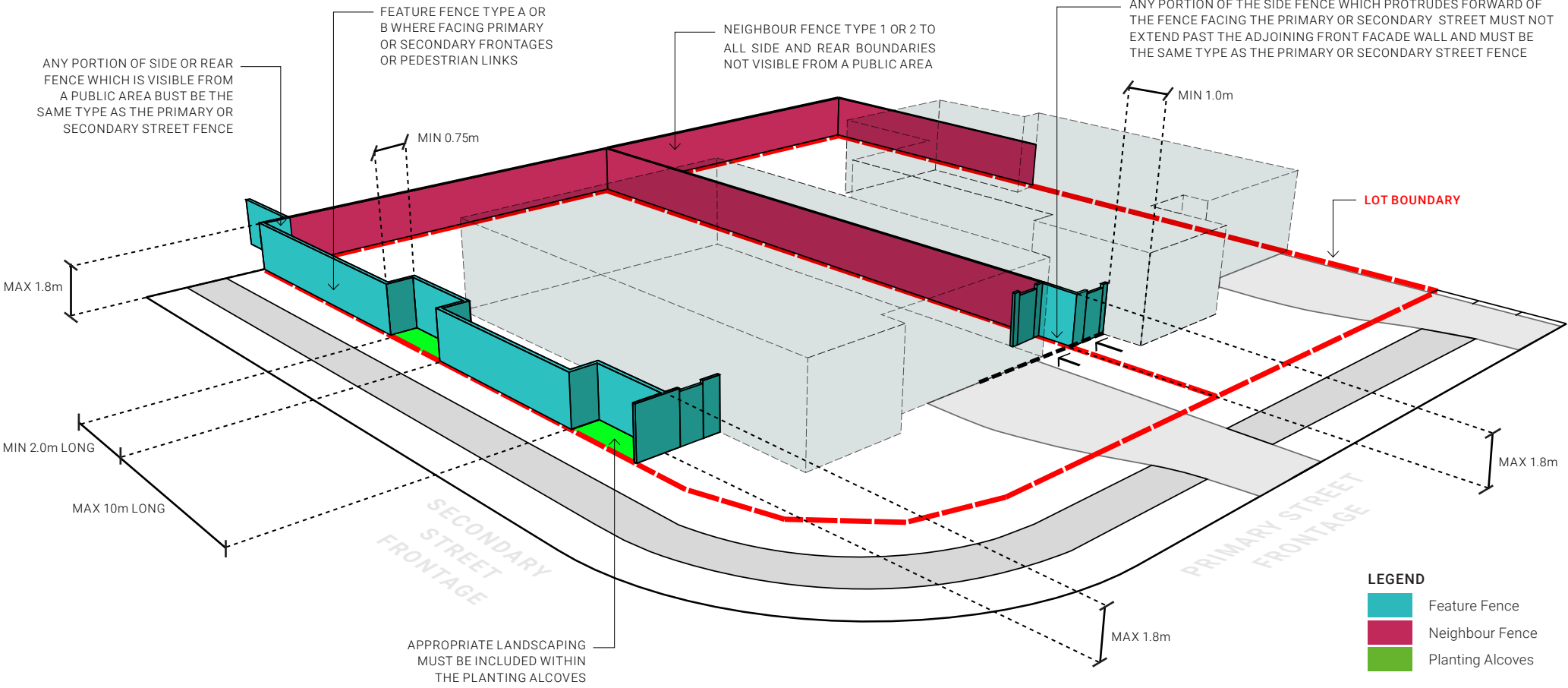

Sustainable Living Guidelines

Mirvac considers sustainability and innovation to be key components in delivering cohesive communities that are safe, encourage healthy and active lifestyles and result in lower household expenses.

Objectives

- To set a new benchmark for high-quality sustainable living, and encourage the incorporation of best practice sustainable initiatives
- To provide and encourage opportunities for residents to reduce their environmental impact
- To provide and encourage opportunities for residents to reduce household expenses during operation

Energy Consumption and Greenhouse gas-emission reduction

- Mirvac encourages all homes to achieve a 7 Star NatHERS rating. This may be achieved through incorporation of the following elements where necessary –
 - Maximising opportunities for cross ventilation and provide high level operable windows in multi-level homes to allow for heat removal
 - Shading designed to restrict solar access to the living spaces in summer, whilst allowing beneficial solar access in winter.
 - Increased rating of the wall and ceiling insulation to the required specification
 - Treated glazing or double glazing where necessary
 - Draft sealing (weather seals on external doors etc.) where necessary
 - Sealed exhaust fans where necessary
- In addition to achieving a 7 Star rating on the building fabric, Mirvac encourage house designs to include the following energy saving features:
 - Gas boosted solar hot water or electric heat pump hot water systems
 - Gas or induction cook tops
 - LED light fittings throughout the home
 - Exterior lighting fitted with motion sensors
 - Low energy use appliances (aim for energy ratings greater than 4 star)
 - Energy efficient air conditioning systems (aim for a COP greater than 3)
 - Standby 'Green Switch' or Smart home automation to reduce energy whilst the home is unoccupied.
 - Solar photovoltaic electricity systems with battery storage

Water Conservation and reuse

- To assist in achieving an overall reduction in household water usage, Mirvac recommends that homes incorporate the following measures:
 - Rainwater tanks for toilet flushing and irrigation
 - Dishwasher and washing machines with a 4 Star or greater WELS rating
 - Tapware and toilets with a 4 Star or greater WELS rating
 - Showers with a 3 Star WELS rating
 - Purchasers are encouraged to consider water efficient landscape design, soil mix, and plant selections, with a target of a minimum of 70% of planted species to be drought tolerant

Materials and Waste

- Maximise the use of standard sizes of materials wherever possible to minimise wastage
- Mirvac recommends the use of low-impact construction materials
 - For masonry consider low impact options, such as recycled or carbon neutral bricks
 - For lightweight construction, consider the use of natural or innovative materials such as timber, structural insulated panels or Hebel for a reduced environmental impact and good thermal performance qualities.
- Internal Finishes
 - Consider the use of flooring, joinery and plasterboard that is environmentally certified by independent certification schemes such as GECA, EcoSpecifier or the Carpet Institute of Australia
 - Select high quality, durable finishes with long warranty periods
- To reduce the airborne chemicals within your home consider the following products
 - Engineered wood products, such as kitchen cabinetry and wardrobes, with low or zero formaldehyde (rated as E1 or E0)
 - Paints, adhesives and carpets rated to have low levels of volatile organic compounds (VOCs)
- To reduce waste to landfill during the operation of your home, consider
 - Installing a dual bin in the kitchen joinery to make recycling as easy as disposing of general waste
 - The use of a worm farm or composting bin to reduce food waste and provide fertiliser for your gardens.

Smart Technology

- Smart monitoring
 - Consider the use of smart meters to help track your energy consumption and reduce your bills even further
- Smart home automation
 - Consider the use of smart home automation to make your life easier and future proof your home. Systems available include:
 - Smart Security systems
 - Smart intercom and access controls
 - Smart controls of lighting, blinds, air conditioning and appliances
 - Audio Visual systems
- If solar electricity and/or batteries are installed, consider a fully electric house to avoid the need for a natural gas connection.

Landscaping

- The use of permeable surfaces is encouraged to maximise opportunities for natural infiltration and groundwater recharge
- The use of waterwise plant species, waterwise irrigation and mulching of garden beds is encouraged to reduce water use
- The planting of trees offering shade for the house and outdoor living areas and contributing to bird habitat is encouraged
- The use of locally native plant species is encouraged to increase biodiversity
- Consider the use of herbs, vegetables and fruit trees to create a productive garden

HOT TIP!

Please refer to Annexure D for the Landscaping Design Guidelines including concepts and example planting palettes to help you achieve a high quality landscape outcome.

Definitions

As Constructed Site Level

The existing level of your lot as constructed during the civil works completed by or on behalf of Mirvac.

Built to Boundary Walls (Zero Lot Boundary)

Refer Plan of Development.

Covenant Bond

A Covenant Bond has been incorporated into the land sales contract for all properties within Everleigh. The fully refundable Covenant Bond serves to ensure that well designed, quality homes are brought to life to make this an attractive community to be proud of.

Design Committee

The entity appointed by Mirvac authorised to approve building applications under these Residential Design Standards & Guidelines.

Façade

Elevation of a building visible from a Public Area. The primary façade is the elevation facing the primary street.

Living Areas

The internal part of your home excluding utility areas such as garage, laundry, bathroom, toilet, hall ways and storage areas.

Local Authority

Logan City Council or the Department of State Development, Manufacturing, Infrastructure and Planning as applicable.

Plan of Development (POD)

The approved Plan of Development – Envelope Plan and Plan of Development – Design Criteria in Annexure A and B.

Primary Street

The street fronting your lot where the lot has only one street frontage; or for lots with two or more street frontages the street which your home's front door is located.

Private Open Space

External areas of your lot with an area and dimensions as required by the Plan of Development. Private Open Space areas are not to contain any service items such as bin store, air conditioning condensers or rainwater tanks, etc. It may be roofed or un-roofed.

Public Area

Any land vested to, or under the control of the Logan City Council. E.g. roads, verges /nature strips, parks, public access ways, etc.

Public Open Space

Public Area excluding roads and verges/nature strips.

Retaining Wall

A retaining wall is defined as any retaining structure higher than 200mm.

Setback

Refer Plan of Development.

Site Coverage

Refer Plan of Development.

Secondary Street

Applies to lots with more than one street frontage and is the street(s) which is not the primary street.





Annexure A

Approved PoD –
Envelope Plan

Everleigh

ROL 5: PLAN OF DEVELOPMENT ENVELOPE PLANS

PLANS AND DOCUMENTS
referred to in the PDA
DEVELOPMENT APPROVAL



Approval no: DEV2020/1160

Date: 26 August 2021

TEVIOT ROAD, EVERLEIGH

21 JULY 2021

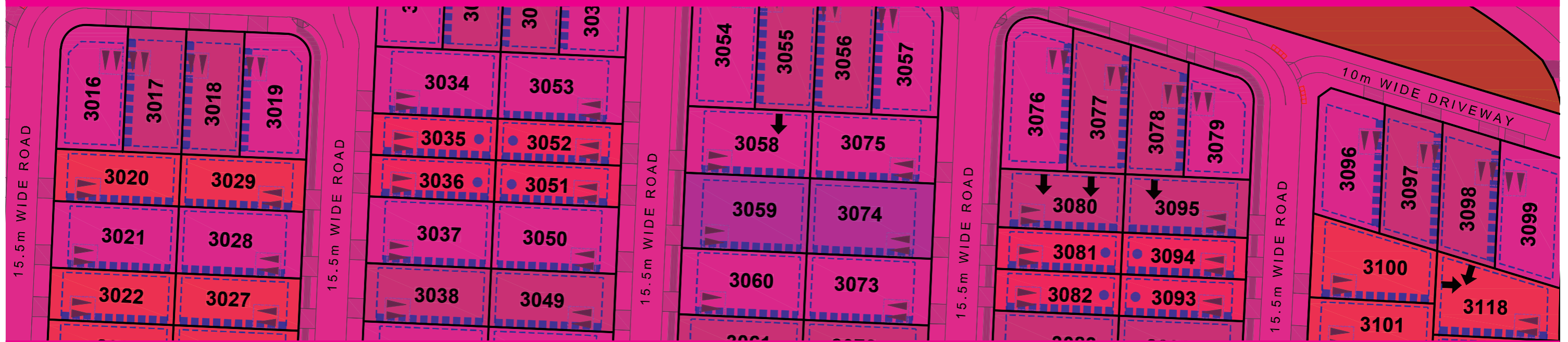

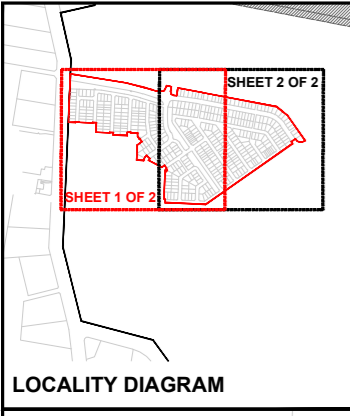

LOCALITY DIAGRAM

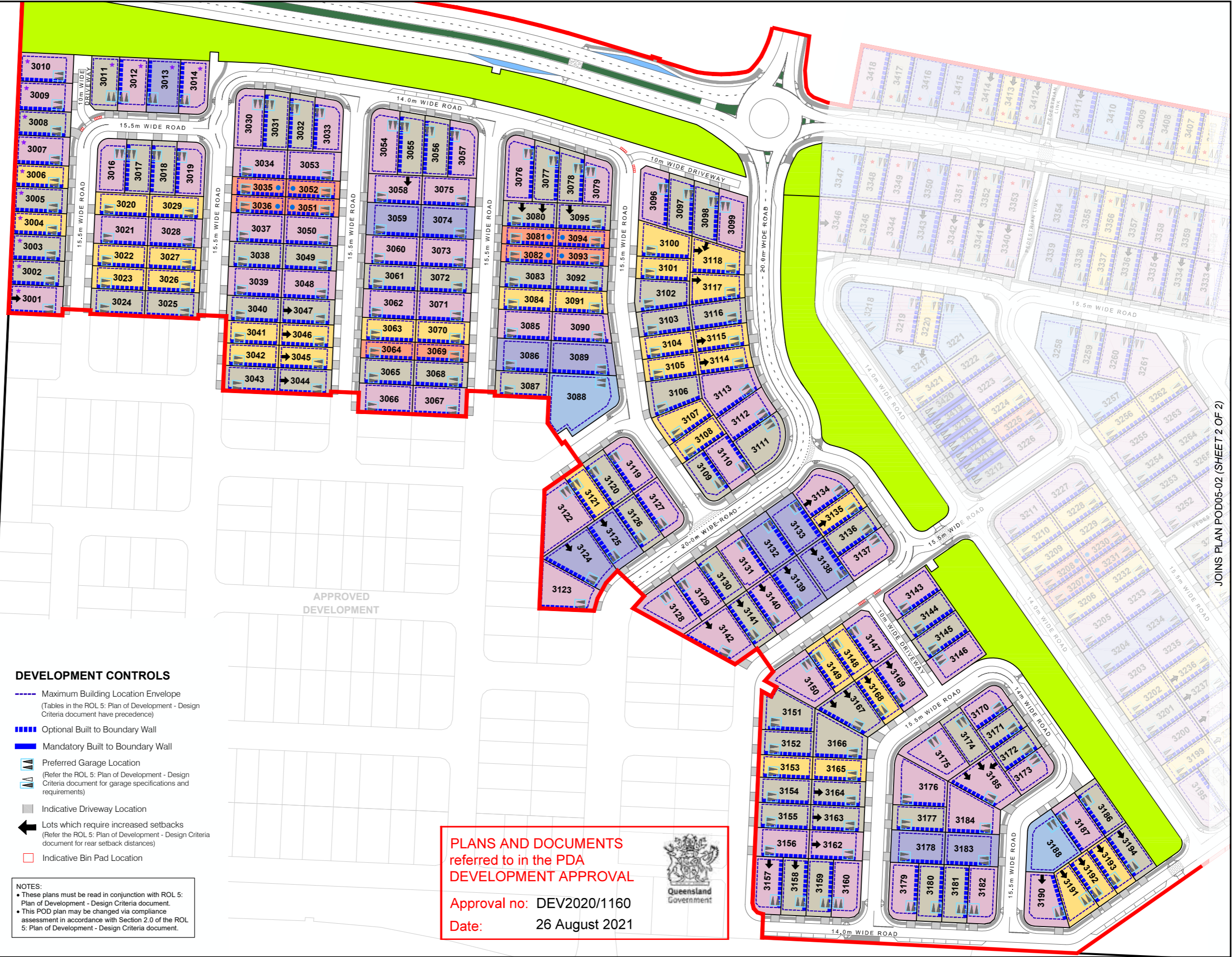

LEGEND

- GENERAL**
- Site Boundary
 - ROL 5 Boundary
 - Indicative Footpath Location
 - Indicative Bus Stop Location
 - ★ Buildings which require acoustic design to upper floors only
 - ★ Buildings which require acoustic design to the ground and upper floors
 - Major Linear Park
 - Central Median Strip

RESIDENTIAL - STANDARD LOTS
HOUSE (ATTACHED)

- Terrace
- Potential Attached Dwelling (refer to House (Attached) Design Criteria which prevails to the extent of any inconsistency with this plan)

HOUSE (DETACHED)

- Villa
- Premium Villa
- Courtyard
- Premium Courtyard
- Traditional
- Premium Traditional

MULTIPLE RESIDENTIAL

- Multiple Residential
- Potential Duplex Dwelling
- MR 2 Max 2 Dwellings
- MR 3 Max 3 Dwellings
- MR 4 Max 4 Dwellings
- Front Loaded
- Rear Loaded
- Dual Loaded

DEVELOPMENT CONTROLS

- Maximum Building Location Envelope (Tables in the ROL 5: Plan of Development - Design Criteria document have precedence)
- Optional Built to Boundary Wall
- Mandatory Built to Boundary Wall
- Preferred Garage Location (Refer the ROL 5: Plan of Development - Design Criteria document for garage specifications and requirements)
- Indicative Driveway Location
- ← Lots which require increased setbacks (Refer the ROL 5: Plan of Development - Design Criteria document for rear setback distances)
- Indicative Bin Pad Location

NOTES:

- These plans must be read in conjunction with ROL 5: Plan of Development - Design Criteria document.
- This POD plan may be changed via compliance assessment in accordance with Section 2.0 of the ROL 5: Plan of Development - Design Criteria document.

PLANS AND DOCUMENTS referred to in the PDA DEVELOPMENT APPROVAL

Approval no: DEV2020/1160
Date: 26 August 2021

JOINS PLAN POD05-02 (SHEET 2 OF 2)

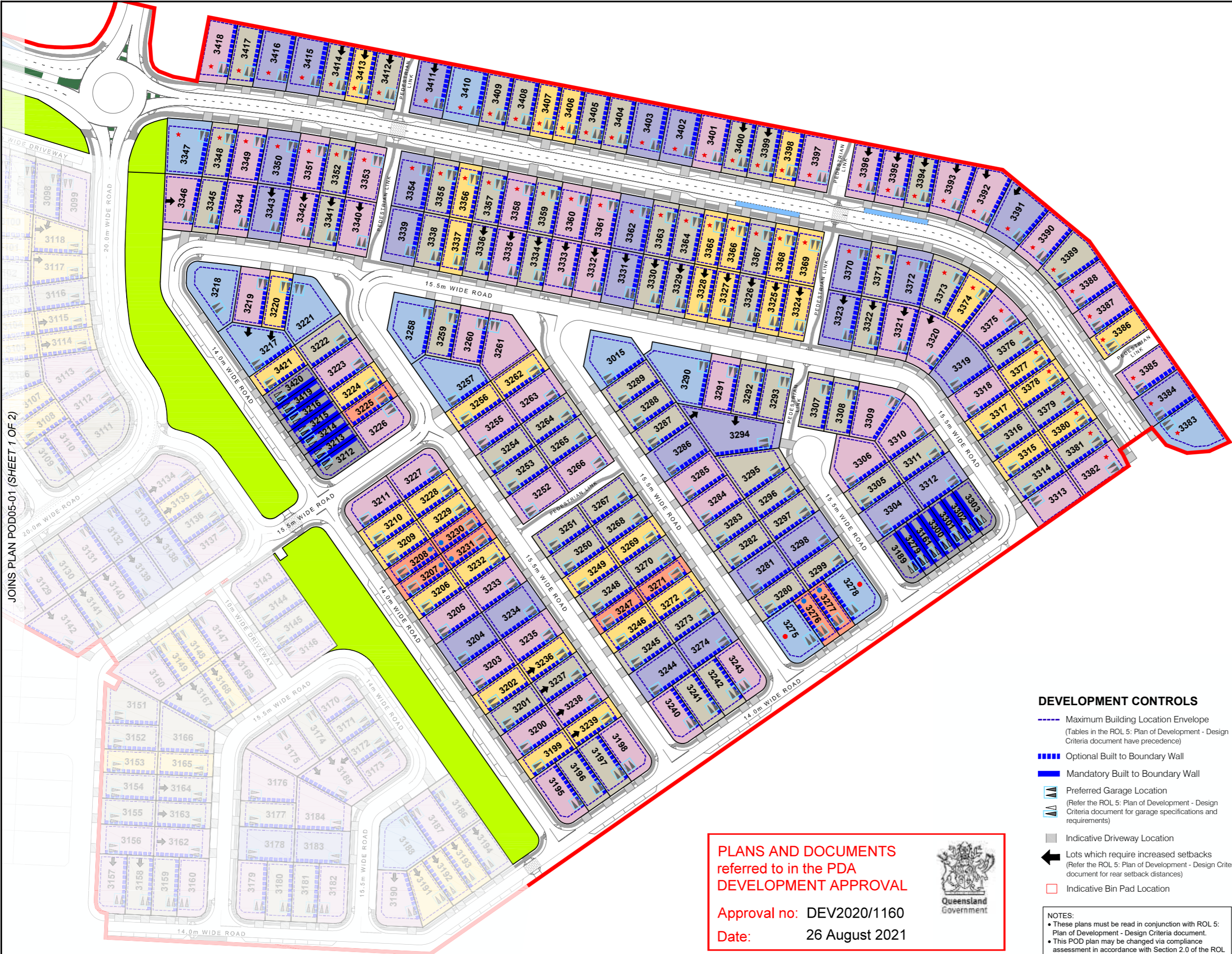
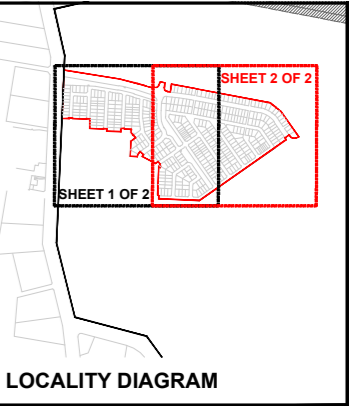

JOINS PLAN POD05-01 (SHEET 1 OF 2)

LEGEND

- GENERAL**
- Site Boundary
 - ROL 5 Boundary
 - Indicative Footpath Location
 - Indicative Bus Stop Location
 - Buildings which require acoustic design to upper floors only
 - Buildings which require acoustic design to the ground and upper floors
 - Major Linear Park
 - Central Median Strip

RESIDENTIAL - STANDARD LOTS
HOUSE (ATTACHED)

- Terrace
- Potential Attached Dwelling (refer to House (Attached) Design Criteria which prevails to the extent of any inconsistency with this plan)

HOUSE (DETACHED)

- Villa
- Premium Villa
- Courtyard
- Premium Courtyard
- Traditional
- Premium Traditional

MULTIPLE RESIDENTIAL

- Multiple Residential
- Potential Duplex Dwelling
- MR 2 Max 2 Dwellings
- MR 3 Max 3 Dwellings
- MR 4 Max 4 Dwellings
- Front Loaded
- Rear Loaded
- Dual Loaded

DEVELOPMENT CONTROLS

- Maximum Building Location Envelope (Tables in the ROL 5: Plan of Development - Design Criteria document have precedence)
- Optional Built to Boundary Wall
- Mandatory Built to Boundary Wall
- Preferred Garage Location (Refer the ROL 5: Plan of Development - Design Criteria document for garage specifications and requirements)
- Indicative Driveway Location
- Lots which require increased setbacks (Refer the ROL 5: Plan of Development - Design Criteria document for rear setback distances)
- Indicative Bin Pad Location

NOTES:

- These plans must be read in conjunction with ROL 5: Plan of Development - Design Criteria document.
- This POD plan may be changed via compliance assessment in accordance with Section 2.0 of the ROL 5: Plan of Development - Design Criteria document.

PLANS AND DOCUMENTS referred to in the PDA DEVELOPMENT APPROVAL

Approval no: DEV2020/1160

Date: 26 August 2021

Annexure B

Approved PoD –
Design Criteria

ROL 5: PLAN OF DEVELOPMENT - DESIGN CRITERIA

PLANS AND DOCUMENTS
referred to in the PDA
DEVELOPMENT APPROVAL



Approval no: DEV2020/1160

Date: 26 August 2021

TEVIOT ROAD, EVERLEIGH

21 JULY 2021

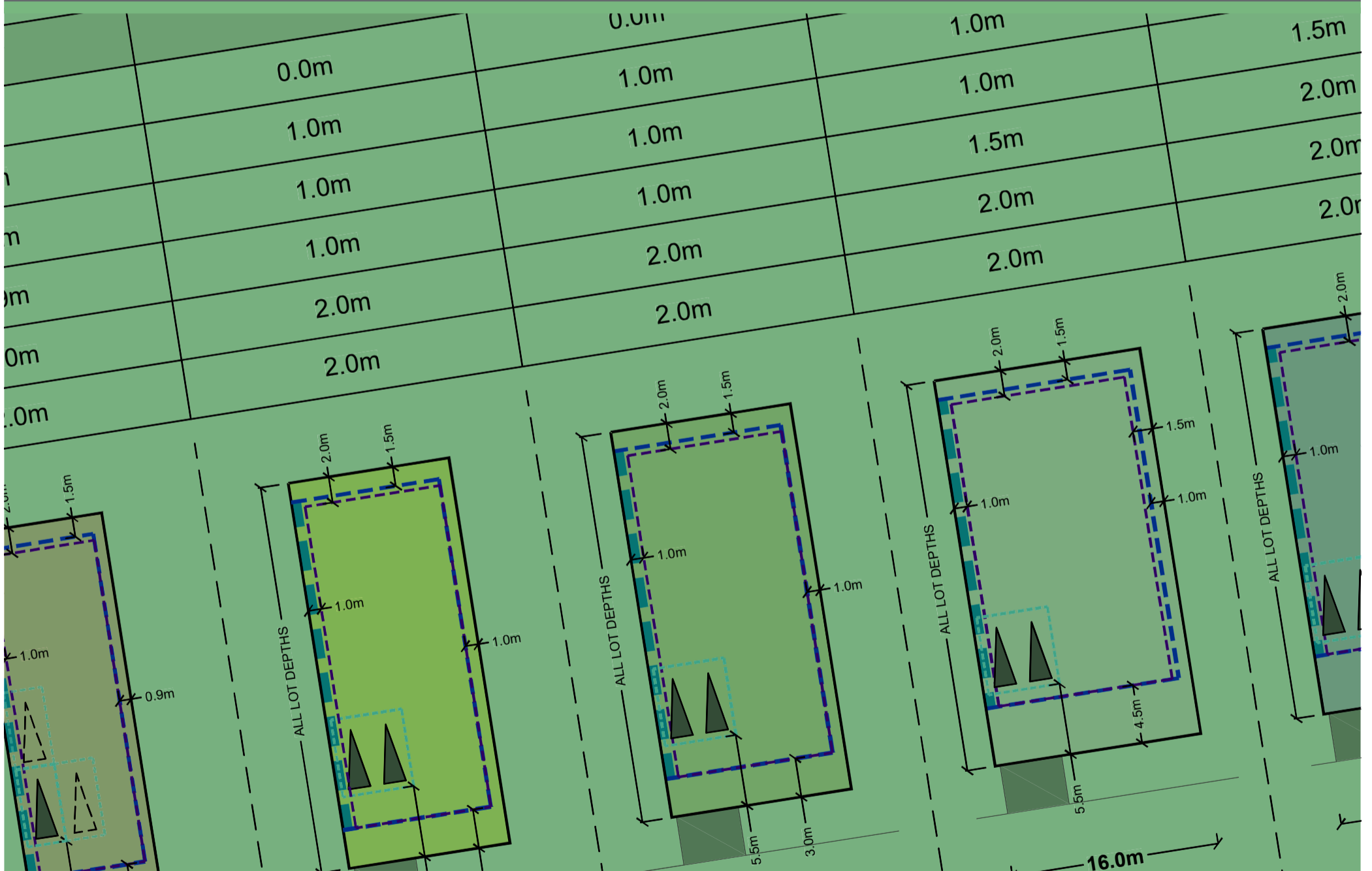

1.0 APPROVED USES

1.1 USES EXEMPT IN ACCORDANCE WITH THE GREATER FLAGSTONE DEVELOPMENT SCHEME WHERE COMPLYING WITH THIS PLAN OF DEVELOPMENT

Uses listed in Table 1 and complying with the relevant Design Criteria (Section 3.0 and Section 4.0) in this Plan of Development and ROL 5: Plan of Development - Envelope Plans document are approved exempt development.

TABLE 1: USES EXEMPT DEVELOPMENT IN ACCORDANCE WITH THE GREATER FLAGSTONE DEVELOPMENT SCHEME WHERE COMPLYING WITH THIS PLAN OF DEVELOPMENT

LAND USES	
<ul style="list-style-type: none"> Display Home House (detached or attached) Park Home Based Business 	<ul style="list-style-type: none"> Multiple Residential - Duplex (Up to 2 dwelling units where identified on the ROL 5: Plan of Development - Envelope Plans) Advertising Device

1.2 USES SUBJECT TO COMPLIANCE ASSESSMENT

Uses listed in Table 2 and complying with the relevant Design Criteria (Section 3.3, 3.4 and 3.5) in this Plan of Development and ROL 5: Plan of Development Envelope Plans document are approved development subject to Compliance Assessment.

TABLE 2: LAND USES USES SUBJECT TO COMPLIANCE ASSESSMENT & DESIGN CRITERIA

LAND USES	
<ul style="list-style-type: none"> Sales Office (up to 400m² GFA) 	<ul style="list-style-type: none"> Multiple Residential - Duplex (Up to 2 dwelling units where identified on the ROL 5: Plan of Development - Envelope Plans)

1.3 DEFINED TERMS

The terms used in this document have a particular meaning as stated in the Greater Flagstone UDA Development Scheme (October 2011) (Development Scheme). The Development Scheme definitions prevail over all other planning instruments to the extent of any inconsistency.

2.0 CRITERIA FOR A CHANGE TO APPROVED LAYOUT FOR EVERLEIGH ROL 5

2.1 DESIGN STANDARDS FOR A CHANGE TO APPROVED RECONFIGURING A LOT LAYOUT AND PLAN OF DEVELOPMENT ENVELOPE PLANS FOR EVERLEIGH ROL 5

The following plans and documents can be amended by compliance assessment where generally in accordance with the design standards in Table 3, or as otherwise agreed with the nominated assessing authority.

- ROL 5: Plan of Development - Envelope Plans (Envelope Plans)
- ROL 5: Reconfiguration of a Lot Plans (RoL Plans)

Figure 1 below identifies those fixed elements of the Envelope Plans and RoL Plans that cannot be adversely impacted or changed.

FIGURE 1: FIXED ELEMENTS - ROL 5

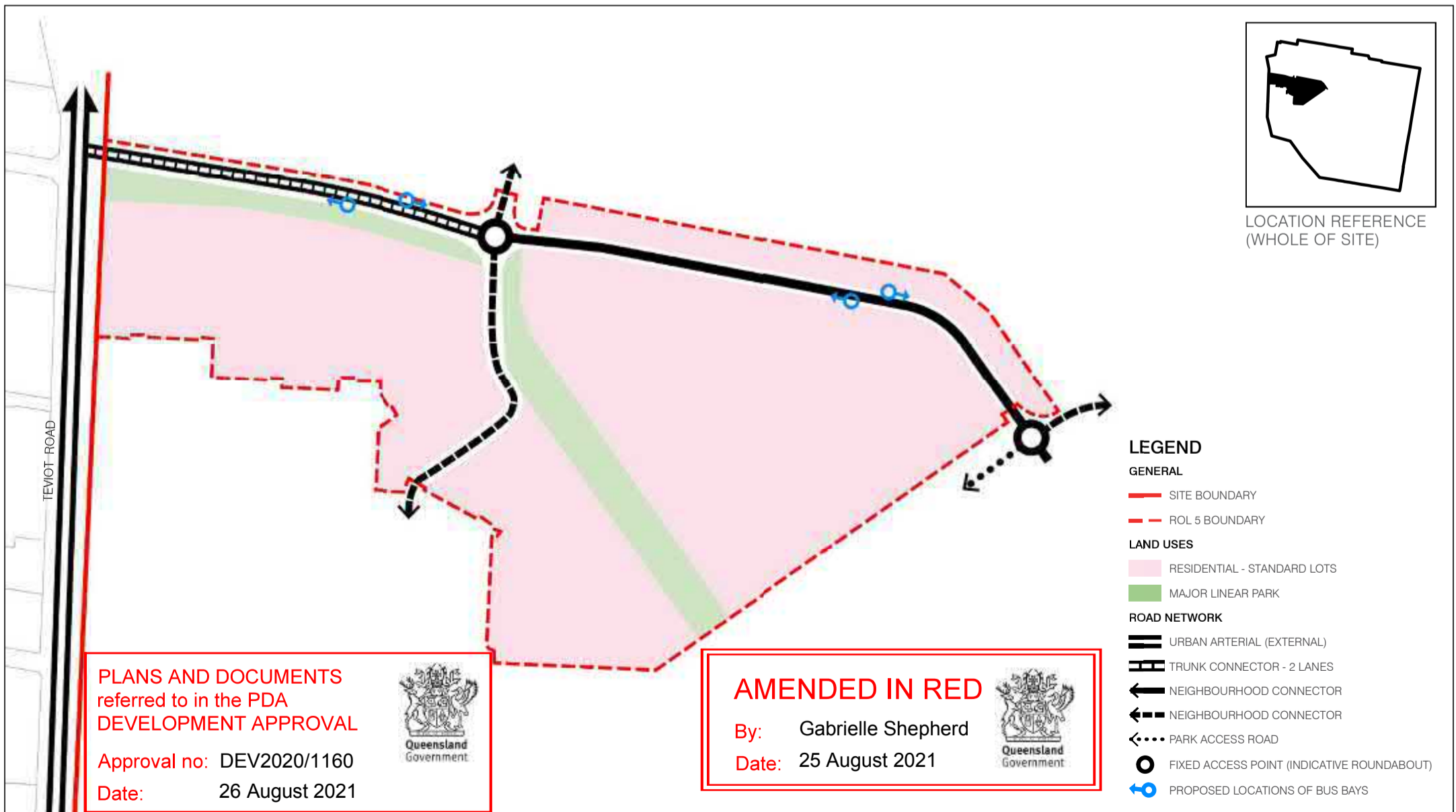

TABLE 3: DESIGN STANDARDS

GENERAL	DESIGN STANDARDS
Development Yield	<ul style="list-style-type: none"> The total development yield is to be between 379 and 463 dwellings (being the originally approved 421 dwellings +/- 10%) where not in conflict with the other requirements of Table 3: Design Standards.
Lot Design	<p>Size & density</p> <ul style="list-style-type: none"> no minimum lot size For Residential - Standard Lots, development achieves a minimum net residential density of 15 dwellings per hectare for ROL 5 <p>Shape</p> <ul style="list-style-type: none"> Width and depth consistent with typical lot dimensions - refer Section 3.0. <p>Slope</p> <ul style="list-style-type: none"> Unless constructed in an integrated or attached development, the finished slope on a lot less than 450m² in area does not exceed: <ul style="list-style-type: none"> 10% side slope 5% lengthwise slope Less, if both figures approach the maximum together. Platform construction required when finished slope on lot is 16% or greater
Block Size	<ul style="list-style-type: none"> Length 100-200 metres Mid-block break providing a pedestrian link when blocks are over 130 metres Depth 40-80 metres
Lot Layout	<ul style="list-style-type: none"> No more than eight narrow (less than 10.0 metres) frontage lots in a row. No more than six lots with a width of 7.5 metres to 5.0 metres in a row unless serviced by a rear lane.
Access	<ul style="list-style-type: none"> 90% of dwellings must be within 400m of a Neighbourhood Recreation Park or other park providing equivalent informal recreation opportunities. 90% of Residential - Standard Lots are within 400 metres of an existing or planned public transport stop.
Street Network	<ul style="list-style-type: none"> Grid pattern or modified grid responsive to site characteristics. Where slope allows, orientation within 15 degrees of north-south or east-west. To minimise cut & fill, streets follow ridges, gullies, and/or are perpendicular to slope. Minimise cul-de-sacs where possible. Where proposed, cul-de-sac length is desirably no greater than 10 lots.
Typical Road Typologies	<ul style="list-style-type: none"> Roads are designed generally in accordance with the approved Context Plan. Street network includes (where relevant): <ul style="list-style-type: none"> A trunk connector providing access to neighbourhood connector streets; Neighbourhood connector streets providing direct access to properties and connections to neighbourhood destinations; Neighbourhood access streets provide direct access to properties and neighbourhood lanes; and Neighbourhood lanes - provide direct property access either at the front or rear of lots.
On-Street Car parking	On-street car parking to be provided at a minimum rate of 0.5 spaces per residential lot.
Total Park Area Required	<ul style="list-style-type: none"> Minimum 1.9 ha

Note: Parks to be provided generally in accordance with the requirements of the Open Space Master Plan Rates of Provision & Accessibility

REFERENCE MATERIAL

PDA Guidelines and Practice Notes	<ul style="list-style-type: none"> Guideline 1 - Residential 30 (May 2015) Guideline 5 - Neighbourhood Planning and Design (May 2015) Guideline 6 - Street and Movement Network (April 2012) Guideline 7 - Low Rise Buildings (May 2015) Guideline 12 - Park Planning and Design (May 2015) Guideline 13 - Engineering Standards (May 2015) Guideline 18 - Development Interfaces (May 2015)
-----------------------------------	---

3.2 HOUSE (ATTACHED)

The following criteria apply to House (attached) proposals.

Planning Context

- In accordance with the provisions of the Greater Flagstone Urban Development Area Development Scheme (October 2011) (Development Scheme), building work and operational work are exempt development where in accordance with, or associated with, this Plan of Development (PoD).
- All relevant provisions of this PoD must be satisfied prior to the issuance of a Building Approval.
- The provisions of the Development Scheme will apply where development does not comply with all provisions of the Plan of Development.
- The Development Scheme definitions prevail over all other planning instruments to the extent of any inconsistency.

General

- All development is to be undertaken in accordance with the Development Approval.
- Nominated building location envelopes may be constrained by future easements and/or services.
- Where allotments are so marked on ROL 5: Plan of Development - Envelope Plans, residential buildings must be designed and constructed to comply with AS3671-1989 Acoustics - Road Traffic Noise Intrusion - Building, Siting and Construction (floor-plan specific acoustic design) or as per acceptable forms of construction from QDC MP4.4 - Buildings in a Transport Noise Corridor. Refer to the approved Noise Impact Assessment for further information.

Setbacks

- Setbacks are as per Table 5: Plan of Development Table - House (Attached) (Table 5), unless specified otherwise on this sheet.
- The permitted location of built to boundary walls are indicated on the ROL 5: Plan of Development - Envelope Plans.
- Where built to boundary walls are not adopted, side setbacks shall be in accordance with the Non-Built to Boundary Wall setbacks nominated in Table 5.
- Length of Built to Boundary walls shall be no more than:
 - 80% for a house on a lot width of 7.5m or less
 - 75% for a house on a lot width of 7.5m - 9.9m
 - 70% for a house on a lot width of 10m - 12.49m
 - 65% for a house on a lot width of 12.5m - 14.9m
 - 60% for a house on a lot width of 15m - 19.9m
 - 55% for a house on a lot width of 20m or greater
- All boundary setbacks are measured to the wall of the structure.
- The dwelling and associated projections (gutters etc.) must be located wholly within the subject lot, unless encroachment rights are secured by way of easement (or other suitable mechanism).
- Other than built to boundary walls, the outside face of the fascia, or the roof structure where there is no fascia, or attached sunhoods or the like (not including retractable blinds, fixed screens, rainwater fittings, or ornamental attachments) of a building is permitted to extend 600mm within the prescribed setback, however cannot encroach closer than 450mm from the boundary.
- For corner lots (excluding a corner intersecting with a laneway), no building or structure over 2m high is built within a 6m x 6m truncation at the corner of two road frontages (refer Table 5).
- The primary street frontage elevation is to be articulated to reduce the mass of the building by one or more of the following:
 - Windows recessed into the façade
 - Balconies, porches or verandahs
 - Window hoods
 - Shadow lines created on the building through minor changes in the façade (100mm minimum).
- Entrance porticoes may be located closer to the property boundary than stated in Table 5 provided that the portico:
 - Is located no less than 1.4m from the front property boundary;

- Does not exceed a maximum height of 4.5m;
- Does not exceed a width of 3.0m; and
- The portico remains open and not enclosed.

Building Height

- The maximum building height is 9.0m.
- Buildings must have no more than 2 storeys.

Site Cover

- The maximum Area covered by all buildings and structures roofed with impervious materials, does not exceed the maximum site cover indicated in Table 5, where Area means:
 - for enclosed spaces, the area including the outside wall; and
 - for unenclosed spaces, the area is measured along a line 600mm in from the perimeter of the roof.

Private Open Space and Amenity

- Buildings must ensure the provision of natural light and ventilation to core living areas.
- Each house / dwelling unit has a clearly defined outdoor living space which:
 - Has an area of at least:
 - 12m² with a minimum dimension of 2.4m for a 3 or more bedroom house / dwelling unit;
 - 9m² with a minimum dimension of 2.4m for a 2 bedroom house / dwelling unit; or
 - 5m² with a minimum dimension of 1.2m for a 1 room or 1 bedroom house / dwelling unit; and
 - Is accessible from a living area; and
 - Has a ground slope of not more than 1 in 10; and
 - Provides visual privacy from outdoor living spaces on adjacent lots.

Eaves and Roof Pitch

- Eaves, or other architectural features which add visual interest to wall/roof junctions (such as parapets), are required to all walls excluding those built to the boundary.
- The maximum roof pitch is 40 degrees.

Parking and Driveways

- A minimum of two on-site car parking spaces must be provided for each dwelling, one of which must be within a garage.
- Garages:
 - Front loaded attached allotments must adhere to the following criteria:
 - For lot frontages less than 10m, single or tandem garages must be used;
 - For lot frontages equal to or greater than 10m and less than 12.5m, double garages can be used where the garage door width does not exceed 4.8m;
 - For lot frontages greater than 12.5m, single, tandem or double garages may be used where the garage door width does not exceed 40% of the lot frontage; and
 - Double garages are to be setback 1.0m behind the main face of the dwelling, excluding balconies.
- The maximum width of a driveway at the lot boundary shall be:
 - 4.8m for a dwelling with a double garage on a lot with a width of 12.5m or greater.
 - 3.5m for a dwelling on a lot with a width between 10m to 12.49m.
 - 3.0m for a dwelling with a single or tandem garage on any lot.
- A maximum of one driveway per dwelling is permitted unless it is a corner lot where a maximum of two driveways are permitted (1 per frontage).
- Where accessed from a laneway, garages are to be paired (built to a common boundary where possible).
- The driveway finish must not be plain concrete.
- Driveways are to be:

- a minimum distance of 6m from an intersection of one street with another street; and
- designed and constructed in accordance with approval / permit requirements of Logan City Council.

Retaining Walls

- Other than walls erected by the developer, retaining walls:
 - must be tiered 1m vertical and 1m horizontal where forward of the building line to any street, park or lane and visible from the public realm; and
 - cannot exceed 1.5m in height without stepping elements incorporated.
- For sloping lots:
 - Where a built to boundary wall is permitted, this wall must be projected to at least 150mm below the likely pad level of the adjacent block. The pad level can be assumed to be the average of the four corners of the adjacent block using the As Built levels. The build down of the built to boundary wall must be in a material consistent with the visible section of the wall immediately above it.
- Where on a lot with a rear retaining wall exceeding 2.0m above ground level (or where identified on the Plan of Development - Envelope Plans), the Rear Setback is as per Table 5.
- All retaining walls over 1.0m in height must be certified by an RPEQ.

Fencing

- For front loaded lots the Primary Frontage requirements are as follows:
 - The maximum fence height is 1.8m;
 - Fences are not permitted along road frontages forward of the building; and
 - Side boundary fences are to be recessed at least 1m behind the wall addressing the primary road frontage (as seen on the right).
- For rear loaded lots the Primary Frontage requirements are as follows:
 - The maximum fence height is 1.2m;
 - Fences are permitted along the Primary Frontage and the side boundaries forward of the façade facing the Primary Frontage; and
 - Fences must be at least 50% transparent.
- For all lots the Secondary Frontage requirements are as follows:
 - Fences may extend beyond the face of the secondary façade only on the basis the fencing visible from the public area is:
 - A maximum fence height of 1.8m;
 - Solid up to a height of 1.2m with any fencing above 1.2m in height being at least 50% transparent or the fence can be at least 25% transparent overall where the transparency is consistent across the full area of the fence (i.e. transparent sections cannot be located solely at ground level); and
 - Does not extend for lengths greater than 10m without a landscaped recess 2m in length and 0.75m deep (as seen on the right).
- Pedestrian link requirements:
 - Fences to pedestrian links:
 - A maximum fence height of 1.8m; and
 - Solid up to a height of 1.2m with any fencing above 1.2m in height being at least 50% transparent or the fence can be at least 25% transparent overall where the transparency is consistent across the full area of the fence (i.e. transparent sections cannot be located solely at ground level).
- Within laneways, 1.8m high fences are permitted to screen private open space, car parking and servicing areas.

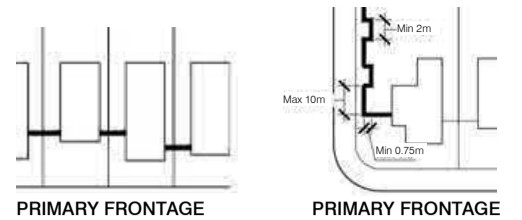

Letterboxes

- For rear loaded lots, letterboxes for the dwelling shall be located on the primary street or park frontage and not in the laneway.

Structures and Services

- All ancillary structures (e.g. garden sheds, gazebos, pools) and services are to be suitably located or screened to minimise detrimental visual impact from public spaces or neighbouring residential allotments, with the exception of solar panels and solar hot water systems which may be located where most efficient.
- Screened drying areas are to be located behind the main face of the dwellings.
- Rubbish bin areas are to be located behind the main face of the dwellings or stored so as to not be visible from the public realm.

Secondary Dwelling

- A secondary dwelling is only permitted where:
 - The lot is 400m² or more;
 - The lot frontage is 12.5m or more; and
 - It complies with the applicable self assessable provisions in Schedule 3 of the Development Scheme where not inconsistent with the provisions of this PoD.
- There is to be no more than one secondary dwelling on a lot.
- Floor area is maximum 45m² GFA (note: GFA excludes the garage and a 4m² size covered entry porch area only)
- Design and siting of buildings and structures to be in accordance with this Plan of Development. Where not on a corner lot, the dwelling/secondary dwelling must have the design effect of one (1) single residential dwelling from the road/street frontage or within public view.
- Materials, detailing colours and roof form are consistent with those of the primary house.
- Outdoor living space is a minimum 9m² with a minimum dimension of 3m and directly accessible from a main living area.
- Car Parking and Garaging is minimum one space in addition to the primary dwelling requirement - with minimum dimensions of 5m x 3m.
- Shared minimum driveway with the primary house.
- If the lot is on a corner the dedicated pedestrian entry and door are visible from and addressing the secondary street.
- Street Surveillance - on a single street frontage the secondary dwelling entry must be hidden from view from the street so as to give the effect that the home is one (1) single residential dwelling.
- Any Secondary Dwelling is not permitted it's own letterbox and must be shared with the primary dwelling.
- Any Secondary Dwelling is unable to be separately titled to the primary dwelling.
- No separate infrastructure servicing to the secondary dwelling is permitted (ie. water, gas, electricity).

Filling and Excavation

- Filling or excavation of a lot is to be a maximum of 50m³ in volume or top dressing of less than 100 vertical millimetres from ground level (ground level definition as per Greater Flagstone Development Scheme)

TABLE 5: PLAN OF DEVELOPMENT TABLE - HOUSE (ATTACHED)

INDICATIVE ALLOTMENT TYPE <i>(Primary reference for allotment type is the ROL5: Plan of Development - Envelope Plans)</i>		FRONT LOADED	REAR LOADED	DUAL LOADED	
FRONT SETBACKS					
PRIMARY FRONTAGE For lots with multiple street frontages: a. A lot only has one primary frontage. b. The primary frontage for a corner lot is as per the ROL 5: Plan of Development - Building Envelope Plan (if nominated)	To Wall (Ground Floor)	3.0m	3.0m	3.0m	
	To Wall (First Floor)	3.0m	3.0m	3.0m	
	To Garage Door	5.0m	N/A	5.0m	
SECONDARY FRONTAGE <i>Note: A Pedestrian Link is not a secondary frontage</i>	To Wall (Ground Floor)	1.5m	1.5m	2.0m	
	To Wall (First Floor)	2.0m	2.0m	2.0m	
	To Garage Door	N/A	N/A	5.0m	
SIDE / REAR SETBACK					
From a boundary of a lot marked (➡) on ROL5: Plan of Development - Envelope Plan or From any part of the side or rear boundary of a lot where: • on the low side of a retaining wall; and • the total wall height at that part of the side or rear boundary is greater than 2.0m total height. <i>Note: Where a retaining wall is less than or equal to 2.0m on any part of the side or rear boundary of a lot, standard setback provisions apply for that part of the side or rear boundary of a lot.</i>		Ground Floor	2.5m	2.5m	2.5m
		First Floor	2.5m	2.5m	2.5m
For all other side / rear boundaries	Rear Setback	Ground Floor	1.5m	1.5m	1.5m
		First Floor	1.5m	1.5m	1.5m
		To Garage Door	N/A	1.5m	N/A
	Side Setback - Built to Boundary	Ground Floor	0-0.3m	0-0.3m	0-0.3m
		First Floor	0-0.3m	0-0.3m	0-0.3m
		Ground Floor	0.9m	1.0m	1.0m
Side Setback - Non-Built to Boundary	First Floor	0.9m	1.0m	1.0m	
	SITE COVER		75%	75%	70%

PLANS AND DOCUMENTS referred to in the PDA DEVELOPMENT APPROVAL

Approval no: DEV2020/1160
Date: 26 August 2021

3.3 MULTIPLE RESIDENTIAL

The following criteria apply to Multiple Residential Proposals.

Planning Context

- In accordance with the provisions of the Greater Flagstone Urban Development Area Development Scheme (October 2011) (Development Scheme), building work and operational work are exempt development where in accordance with, or associated with, this Plan of Development (PoD).
- All relevant provisions of this PoD must be satisfied prior to the issuance of a Building Approval.
- The provisions of the Development Scheme will apply where development does not comply with all provisions of the Plan of Development.
- The Development Scheme definitions prevail over all other planning instruments to the extent of any inconsistency.

General

- All development is to be undertaken in accordance with the Development Approval.
- Nominated building location envelopes may be constrained by future easements and/or services.
- Where allotments are so marked on ROL 5: Plan of Development - Envelope Plans, residential buildings must be designed and constructed to comply with AS3671-1989 Acoustics - Road Traffic Noise Intrusion - Building, Siting and Construction (floor-plan specific acoustic design) or as per acceptable forms of construction from QDC MP4.4 - Buildings in a Transport Noise Corridor. Refer to the approved Noise Impact Assessment for further information.

Setbacks

- Setbacks are as per Table 6: Plan of Development Table - Multiple Residential (Table 6), unless specified otherwise on this sheet.
- All boundary setbacks are measured to the wall of the structure.
- The dwelling and associated projections (gutters etc.) must be located wholly within the subject lot, unless encroachment rights are secured by way of easement (or other suitable mechanism).
- Other than built to boundary walls, the outside face of the fascia, or the roof structure where there is no fascia, or attached sunhoods or the like (not including retractable blinds, fixed screens, rainwater fittings, or ornamental attachments) of a building is permitted to extend 600mm within the prescribed setback, however cannot encroach closer than 450mm from the boundary.
- For corner lots (excluding a corner intersecting with a laneway), no building or structure over 2m high is built within a 6m x 6m truncation at the corner of two road frontages (refer Table 6).
- The primary street frontage elevation is to be articulated to reduce the mass of the building by one or more of the

following:

- Windows recessed into the façade
 - Balconies, porches or verandahs
 - Window hoods
 - Shadow lines created on the building through minor changes in the façade (100mm minimum).
- Entrance porticoes may be located closer to the property boundary than stated in the Table 6 provided that the portico:
 - Is located no less than 1.4m from the front property boundary;
 - Does not exceed a maximum height of 4.5m;
 - Does not exceed a width of 3.0m; and
 - The portico remains open and not enclosed.

Building Height

- The maximum building height is 9.0m.
- Buildings must have no more than 2 storeys.

Site Cover

- The maximum Area covered by all buildings and structures roofed with impervious materials, does not exceed the maximum site cover indicated in Table 6, where Area means:
 - for enclosed spaces, the area including the outside wall; and
 - for unenclosed spaces, the area is measured along a line 600mm in from the perimeter of the roof.

Private Open Space and Amenity

- Each house / dwelling unit has a clearly defined outdoor living space which:
 - Has an area of at least:
 - 12m² with a minimum dimension of 2.4m for a 3 or more bedroom house / dwelling unit;
 - 9m² with a minimum dimension of 2.4m for a 2 bedroom house / dwelling unit; or
 - 5m² with a minimum dimension of 1.2m for a 1 room or 1 bedroom house / dwelling unit.
 - Is accessible from a living area;
 - Has a ground slope of not more than 1 in 10; and
 - Provides visual privacy from outdoor living spaces on adjacent lots.

Or communal open space is provided which:

- has an area of at least 25% of the area of the lot; and
 - is of a shape which can include a circle with a 4.0m diameter.
- Buildings must ensure the provision of natural light and ventilation to core living areas.

Eaves and Roof Pitch

- Eaves, or other architectural features which add visual interest to wall/roof junctions (such as parapets), are required to all walls.

- The maximum roof pitch is 40 degrees.

Parking and Driveways

- A minimum of two on-site car parking spaces must be provided for each dwelling, one of which must be within a garage.
- For all front-loaded attached allotments, garages are not to dominate the streetscape.
- A maximum of one driveway per dwelling permitted.
- Where accessed from a laneway, garages are to be paired where possible.
- The driveway finish must not be plain concrete.
- Driveways are to be:
 - a minimum distance of 6m from an intersection of one street with another street; and
 - designed and constructed in accordance with approval / permit requirements of Logan City Council.

Retaining Walls

- Other than walls erected by the developer, retaining walls:
 - must be tiered 1m vertical and 1m horizontal where forward of the building line to any street, park or lane and visible from the public realm; and
 - cannot exceed 1.5m in height without stepping elements incorporated.
- All retaining walls over 1.0m in height must be certified by an RPEQ.

Fencing

- For front loaded dwellings the Primary Frontage requirements are as follows:
 - The maximum fence height is 1.8m;
 - Fences are not permitted along road frontages forward of the building; and
 - Side boundary fences are to be setback at least 1m behind the face of the wall addressing the primary road frontage (as seen on the right).
- For rear loaded dwellings the Primary Frontage requirements are as follows:
 - The maximum fence height is 1.2m;
 - Fences are permitted along the Primary Frontage and the side boundaries forward of the façade facing the Primary Frontage; and
 - Fences must be at least 50% transparent.
- For all dwellings the Secondary Frontage requirements are as follows:
 - Fences may extend beyond the face of the secondary façade only on the basis the fencing visible from the public area is:
 - A maximum fence height of 1.8m;
 - Solid up to a height of 1.2m with any fencing above 1.2m in height being at least 50%

transparent or the fence can be at least 25% transparent overall where the transparency is consistent across the full area of the fence (i.e. transparent sections cannot be located solely at ground level); and

- Does not extend for lengths greater than 10m without a landscaped recess 2m in length and 0.75m deep (as seen below).

Pedestrian link requirements:

- Fences to pedestrian links:
 - A maximum fence height of 1.8m; and
 - Solid up to a height of 1.2m with any fencing above 1.2m in height being at least 50% transparent or the fence can be at least 25% transparent overall where the transparency is consistent across the full area of the fence (i.e. transparent sections cannot be located solely at ground level).
- Within laneways, 1.8m high fences are permitted to screen private open space, car parking and servicing areas.

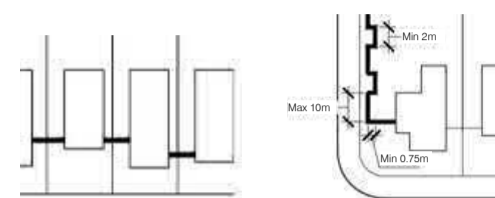

PRIMARY FRONTAGE

PRIMARY FRONTAGE

Letterboxes

- For rear loaded dwellings, letterboxes shall be located on the primary street or park frontage and not in the laneway.

Structures and Services

- All ancillary structures (e.g. garden sheds, gazebos, pools) and services are to be suitably located or screened to minimise detrimental visual impact from public spaces or neighbouring residential allotments, with the exception of solar panels and solar hot water systems which may be located where most efficient.
- Screened drying areas are to be located behind the main face of the dwellings.
- Rubbish bin areas are to be located behind the main face of the dwellings or stored so as to not be visible from the public realm.

Filling and Excavation

- Filling or excavation of a lot is to be a maximum of 50m³ in volume or top dressing of less than 100 vertical millimetres from ground level (ground level definition as per Greater Flagstone Development Scheme)

TABLE 6: PLAN OF DEVELOPMENT TABLE - MULTIPLE RESIDENTIAL

INDICATIVE ALLOTMENT TYPE (Primary reference for allotment type is the ROL5: Plan of Development - Envelope Plans)		FRONT LOADED	REAR LOADED	DUAL LOADED
FRONT SETBACKS				
PRIMARY FRONTAGE For lots with multiple street frontages: a. A lot only has one primary frontage. b. The primary frontage for a corner lot is as per the ROL 5: Plan of Development - Building Envelope Plan (if nominated)	To Wall (Ground Floor)	3.0m	3.0m	3.0m
	To Wall (First Floor)	3.0m	3.0m	3.0m
	To Garage Door	5.0m	N/A	5.0m
SECONDARY FRONTAGE <i>Note: A Pedestrian Link is not a secondary frontage</i>	To Wall (Ground Floor)	1.5m	1.5m	2.0m
	To Wall (First Floor)	2.0m	2.0m	2.0m
	To Garage Door	N/A	N/A	5.0m
SIDE / REAR SETBACK				
From any part of the side or rear boundary of a lot where: • on the low side of a retaining wall; and • the total wall height at that part of the side or rear boundary is greater than 2.0m total height. <i>Note: Where a retaining wall is less than or equal to 2.0m on any part of the side or rear boundary of a lot, standard setback provisions apply for that part of the side or rear boundary of a lot.</i>	Ground Floor	2.5m	2.5m	2.5m
	First Floor	2.5m	2.5m	2.5m
For all other side / rear boundaries	Rear Setback	Ground Floor	1.5m	1.5m
		First Floor	1.5m	1.5m
		To Garage Door	N/A	1.5m
	Side Setback - Non-Built to Boundary	Ground Floor	1.0m	1.0m
First Floor		1.0m	1.0m	1.5m
SITE COVER		75%	75%	70%

3.4 SALES OFFICE

The following criteria apply to a Sales Office:

- The hours of operation of the sales office do not commence before 7am or extend later than 6pm.
- A minimum of 2 on-site car parking spaces are provided.
- Private open space and public frontage are turfed and landscaped.

PLANS AND DOCUMENTS referred to in the PDA DEVELOPMENT APPROVAL

Approval no: DEV2020/1160
Date: 26 August 2021

4.0 ADVERTISING DEVICES

Advertising Devices in accordance with the controls on this sheet are exempt in accordance with this Plan of Development.

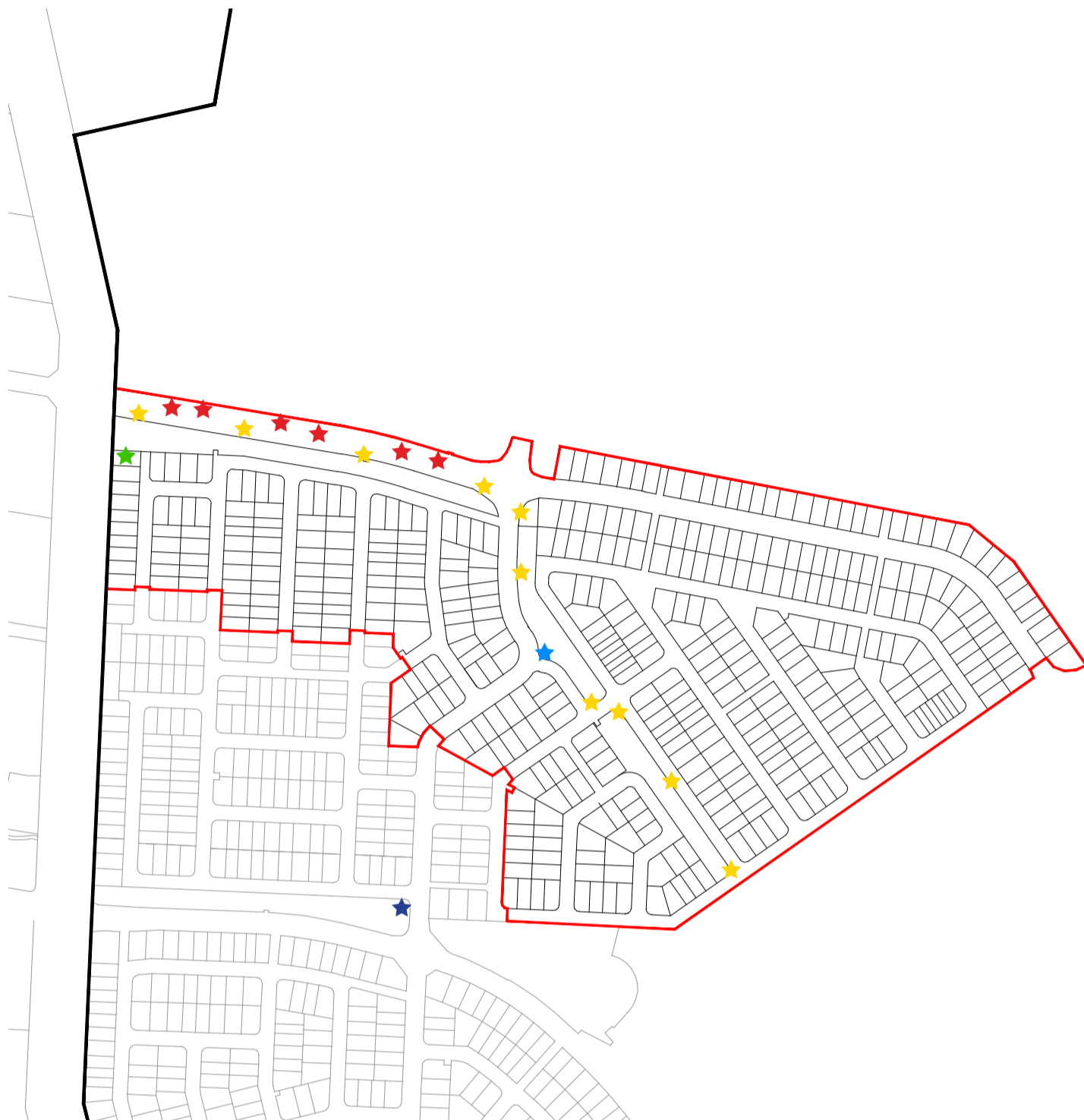

PLANS AND DOCUMENTS
referred to in the PDA
DEVELOPMENT APPROVAL



Approval no: DEV2020/1160
Date: 26 August 2021

Notes:

Currency period

- Unless otherwise agreed to in writing, all advertising devices nominated on this plan are not permitted to remain longer than 20 years from either the date that approval is granted for the last lot or once the last residential lot is sold within the estate, whichever is the earliest.
- After these times, the Advertising Devices must be removed.

Construction

- Construction of Advertising Devices is limited to 6:30am – 6:30pm Monday to Saturday, and may not occur outside of these hours, on Sundays or on public holidays.

Visual amenity and safety of movement

- An advertising device is not to be animated or revolve or flash.
- The advertising devices are to be treated to reduce glare and reflectivity.

Standards for signs

- A Banner Sign is permitted where complying with the following criteria:
 - Does not exceed a maximum sign face area of 2.5m²
 - Where a flag on a flagpole:
 - Does not exceed a maximum height of 9m;
 - Is set a minimum of 2.4m from ground level; and
 - Is limited to 1 flag per 10m of street front boundary.
- Building / Structure Façade Sign is permitted where complying with the following criteria:
 - The sign is painted on, attached to or otherwise incorporated into a wall of a building / structure does not project above the wall of the building / structure;
 - The sign is painted on, attached to or otherwise incorporated into a window of a building is limited to a window on the ground floor of the building;
 - The sign is painted on, attached to or otherwise incorporated into the fascia of a building:
 - Does not project above or below the fascia of the building;
 - Has a maximum height of 30% of the height of the building / structure; and
 - Has a maximum total face of 25% of the building façade.
- Directional Sign is permitted where complying with the following criteria:
 - Has a maximum height of 1.2m above ground level; and
 - Has a maximum total face area of 1m².
- Free Standing Sign is permitted where complying with the

following Criteria:

- Has a maximum height of 8m;
 - Has a maximum width of 6m per advertising face;
 - Being a pole, pylon or billboard sign or v sign, has a minimum clearance above ground level of 2.4m where pedestrian access is to occur under the Free Standing Sign;
 - For billboard and v signs, avoids visual clutter by adhering to the following:
 - No more than 2 billboard or v signs are erected per 100m of road frontage to the site;
 - A separation of at least 60m from another billboard or v sign on the same road frontage, or 200m if either sign has an electronic component; and
 - Does not include bunting.
- Sales Office Sign is permitted where complying with the following criteria:
 - Is located on premises lawfully operating as a Sales Office;
 - Limited to 1 per road frontage; and
 - Has a maximum face area of 5m²
 - A Third Party Sign is permitted to be erected on land owned or under the control of Mirvac, and intended to advertise the emerging community.

Definitions:

Advertising Device

Any permanent structure, device, sign or the like intended for advertising purposes. It includes any framework, supporting structure or building feature that is provided exclusively or mainly as part of the advertisement.

Banner Sign

A device that:

- comprises only cloth, paper, flexible plastic, fabric or other non-rigid material; and
- is suspended from a structure or pole with or without supporting framework.

Building / Structure Façade Sign

A sign which is painted on, attached to or otherwise incorporated into the wall, window, canopy or fascia of a building or structure.

Note—Examples of a building façade sign:

- Awning fascia sign being an advertising device painted on, attached to or incorporated into the fascia of an awning, balcony or veranda.
- Canopy sign being an advertising device painted on or otherwise incorporated into a canopy of a building.
- Hamper sign being an advertising device painted on, attached to or otherwise incorporated into the area between a door head and the underside of an awning, balcony or

veranda.

- Building name sign being an advertising device painted on, attached to or otherwise incorporated into the wall of a building naming or identifying a building by the use of a logo or the like.
- Wall sign being an advertising device painted on, attached to or otherwise incorporated into a wall of a building or structure (fence).
- Window sign being an advertising device painted on, attached to or otherwise incorporated into a window of a building.

Directional Sign

A sign providing information in respect of the operation of an activity on the premises.

Note—Examples of a directional sign:

- entrance sign;
- parking sign;
- menu board.

Face Area

In relation to an advertising device, where the advertising device has:

- only one face, the greater of the area of:
 - the advertisement panel or board as installed; or
 - a rectangular figure best enclosing the advertising message, logo or figure;
- more than one face, the sum of the area of each of the faces where each is calculated separately in accordance with paragraph (a).

Free Standing Sign

A sign permanently attached to the ground on its supportive structure independent of any building.

Note—Examples of a freestanding sign:

- A billboard sign being an advertising device the width of which is greater than the height and which may be positioned on the ground or mounted on one or many vertical supports;
- A v sign being an advertising device the width of which is greater than the height and which may be positioned on the ground or mounted on one or many vertical supports where the two advertising faces are arranged at an angle to each other addressing the road frontage;
- A ground sign being an advertising device which in effect sits on or rises out of the ground;
- A pole sign being an advertising device which may be positioned on the ground or mounted on one or more supports;
- A vertical banner free standing sign being an advertising device of non-rigid material normally fixed at the top and bottom to brackets extending from a freestanding pole.

Legend

- Site Boundary
- ROL 5 Boundary
- 6 x Double Sided Banner Poles
- 10 x 1500mm x 650mm Double Sided Signs
- 1 x 1500mm x 650mm Display Village 2 Sign
- 1 x 3000mm x 1300mm Double Sided Signs
- 6m x 3m Billboard

FIGURE 2: INDICATIVE LOCATIONS OF PRIMARY ADVERTISING DEVICES

Annexure C

Fence Types

NEIGHBOUR FENCE

NEIGHBOUR FENCE TYPE 1 — TIMBER PALING FENCE

HOT TIP!

Retaining walls to be constructed by Mirvac have been designed to allow these fences to be attached using cleats. Speak to the Sales Team or refer to the **Building @ Everleigh Portal** for further detail.

FINISHES

- Timber paling fence
- Unpainted
- Pine palings
- Posts and rails to be hardwood, recommended grade F14, durability Class 1
- Any timber in contact with ground to be H4treated minimum



FENCE TYPE 1 EXAMPLE



Front view

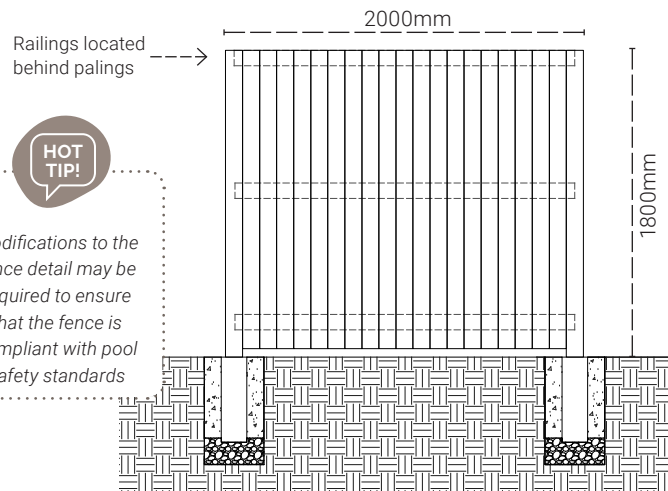

Side view

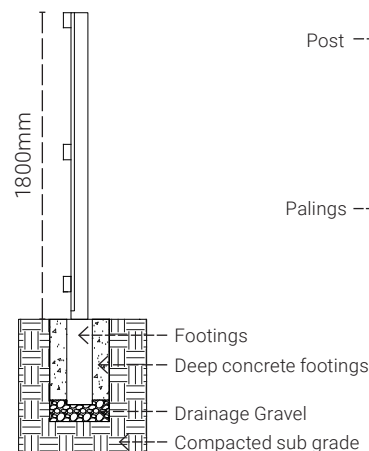

Plan view

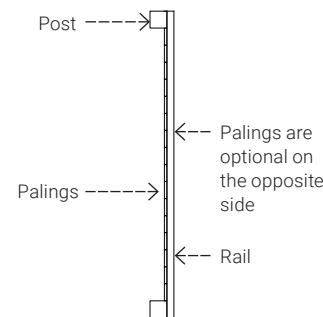

HOT TIP!

Check with your Builder or Engineer on correct fence footings detail.

Specifications:

Posts

- Spacing nominal 2m
- Corner posts/End posts 100x100
- Intermediate posts 100x75
- Height 1.8m above finished level

Rails

- 3 required
- 90 x 40

Palings

- 100x16
- Nominal 0mm gap between palings

NEIGHBOUR FENCE

NEIGHBOUR FENCE TYPE 2 — GOOD NEIGHBOUR PINE FENCE

HOT TIP!

Retaining walls to be constructed by Mirvac have been designed to allow these fences to be attached using cleats. Speak to the Sales Team or refer to the **Building @ Everleigh Portal** for further detail.

FENCE TYPE 2: EXAMPLE

FINISHES

- Good Neighbour Pine Fence
- Painted / Unpainted
- Pine palings
- Posts and rails to be hardwood, recommended grade F14, durability Class 1
- Any timber in contact with ground to be H4 treated minimum

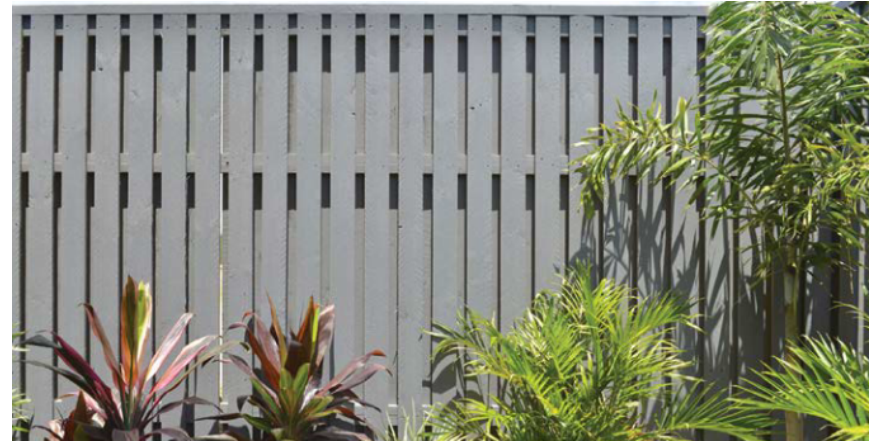

Front view

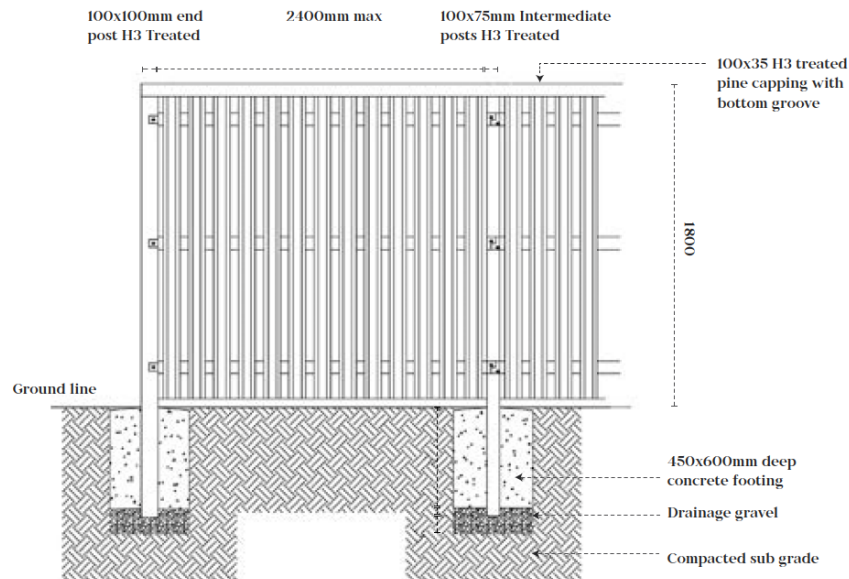

Side view

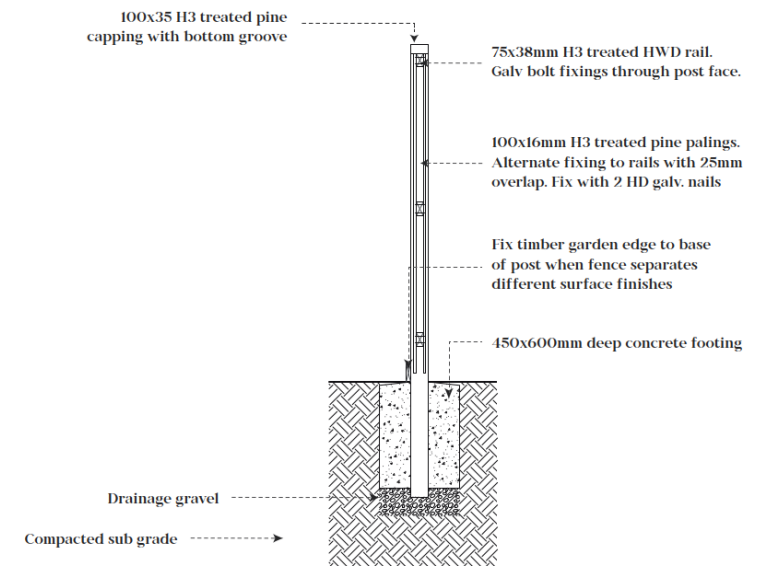

HOT TIP!

Modifications to the fence detail may be required to ensure that the fence is compliant with pool safety standards

FEATURE FENCE

FEATURE FENCE TYPE A — DRESSED HARDWOOD VERTICAL BATTENS

FINISHES

- All timber to be hardwood, recommended grade F14, durability Class 1
- Any timber in contact with ground to be H4 treated minimum
- Vertical battens to be dressed all round
- 2 coats of intergrain ultradeck (natural) minimum standard

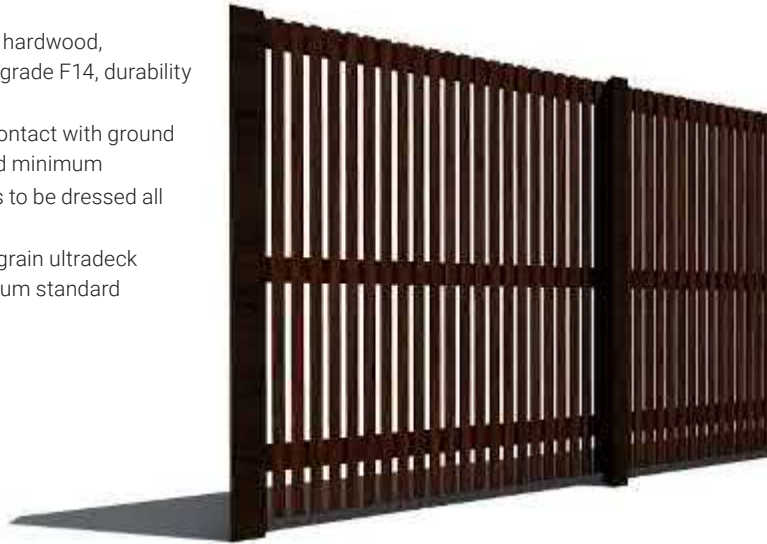

FENCE TYPE A EXAMPLE



Retaining walls to be constructed by Mirvac have been designed to allow these fences to be attached using cleats. Speak to the Sales Team or refer to the **Building @ Everleigh Portal** for further detail.

Front View

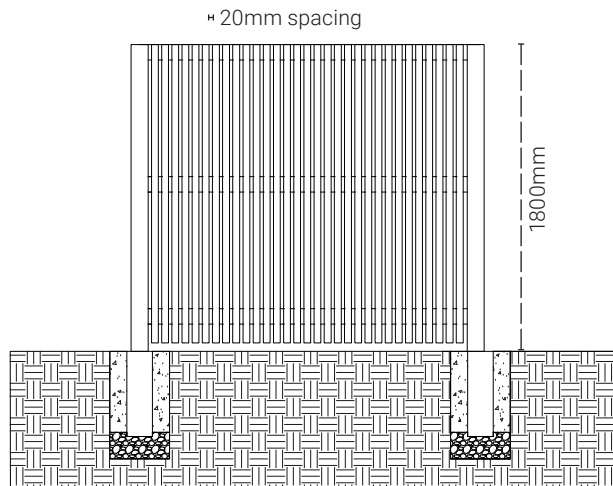

Side view

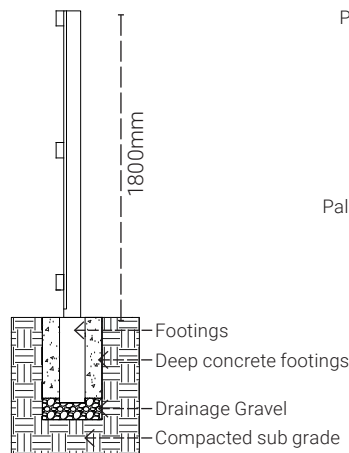

Plan view

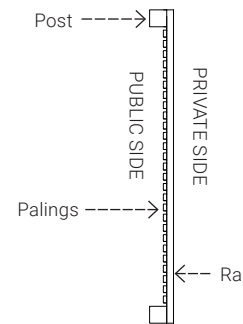

Check with your Builder or Engineer on correct fence footings detail.

Specifications:

Posts

- Spacing nominal 1.5 metres
- Corner posts/End posts 100x100
- Intermediate posts 100x75
- Height 1.8m above finished level

Rails

- 3 required
- 90 x 40

Palings

- 20 x 40
- 20mm gap (minimum) between palings

FEATURE FENCE

FEATURE FENCE TYPE B — ROUGH SAWN HARDWOOD VERTICAL BATTENS



Retaining walls to be constructed by Mirvac have been designed to allow these fences to be attached using cleats. Speak to the Sales Team or refer to the **Building @ Everleigh Portal** for further detail.

FINISHES

- All timber to be hardwood, recommended grade F14, durability Class 1
- Any timber in contact with ground to be H4 treated minimum
- Arris all exposed edges (5mm)
- Mechanical wire brush palings
- 2 coats of intergrain ultradeck (natural) minimum standard



FENCE TYPE B EXAMPLE



Front View

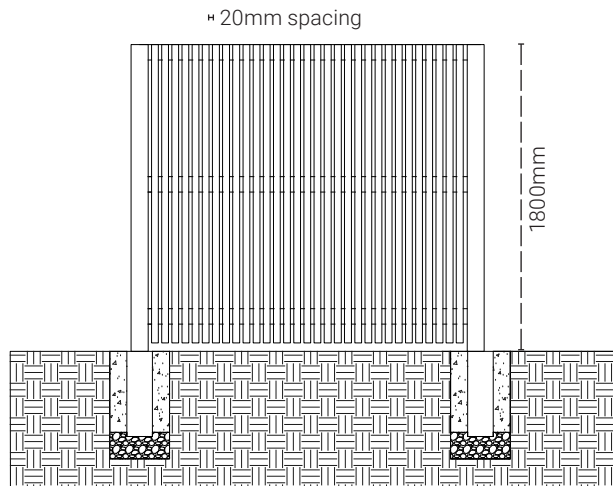

Side view

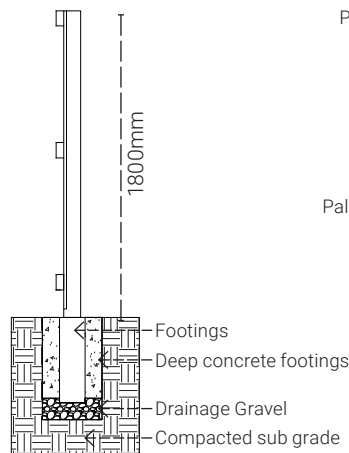

Plan view

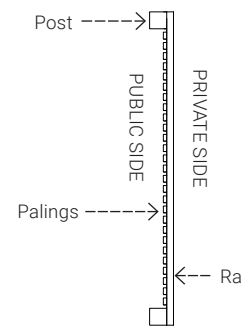

Check with your Builder or Engineer on correct fence footings detail.

Specifications:

Posts

- Spacing nominal 1.5 metres
- Corner posts/End posts 100x100
- Intermediate posts 100x75
- Height 1.8m above finished level

Rails

- 3 required
- 90 x 40

Palings

- 20 x 40
- 20mm gap (minimum) between palings

Annexure D

Landscape Design Guidelines

Everleigh Landscape Design Guidelines

The following planting plans present typical garden layouts.

Plans require customisation to suit the unique site conditions.

Designs must meet requirements outlined in the Part 2: Architectural and Landscape Design Standards of the Everleigh Residential Design Standards & Guidelines.

Refer to the plant palette for recommended species list.

HOT TIP!

Be sure to seek advice from your engineer for any retaining walls or fencing requirements.

General Landscape Design Notes

Give consideration to the following:

- Protect and enhance favourable existing views and vistas through considerate placement of trees and shrubs
- Locate trees and shrubs to provide adequate privacy between neighbours and the public realm
- Provide a balance of sun penetration, shading and wind screening
- Consider the location of windows and the mature heights of shrubs when planting around the house perimeter to preserve views into the garden and prevent overshadowing of the interior
- Consider service locations and potential conflicts with trees
- Provide safe and comfortable access to gates and doorways
- Ensure pathways and pavements are stable, even and non-slip in all weather conditions with adequate crossfalls to prevent ponding of water
- Do not plant spiky plants next to pathways
- Maintain adequate sightlines for drivers and pedestrians in the vicinity of driveways and ensure plants with a mature height of under 500mm are chosen for critical locations
- Manage site water to ensure stormwater runs off away from buildings and waterlogging is minimised
- Consider the site's aspect and predict the amount of sun and shade plants will likely receive when selecting species from the plant palette

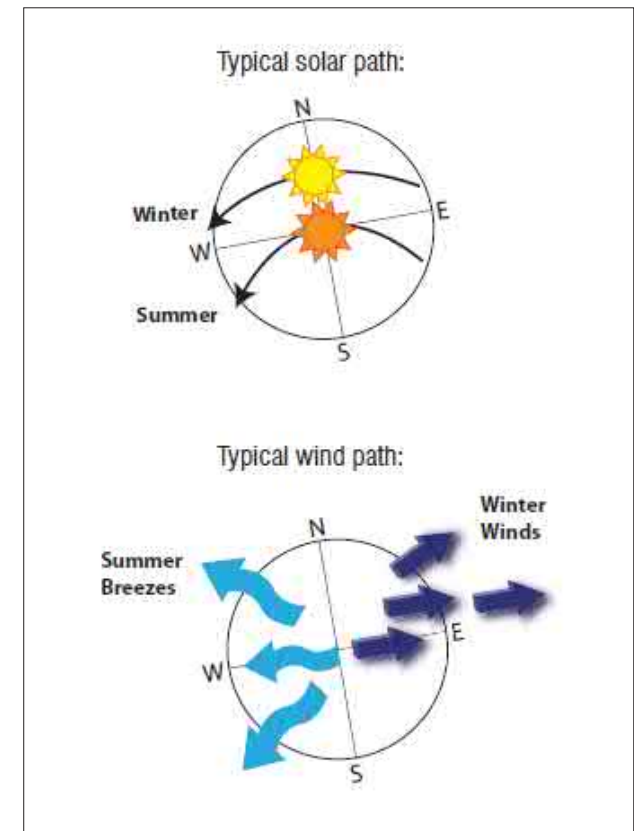

Everleigh

Landscape Design Guidelines

LANDSCAPE DESIGN EXAMPLES

TYPICAL LOT

Example 1

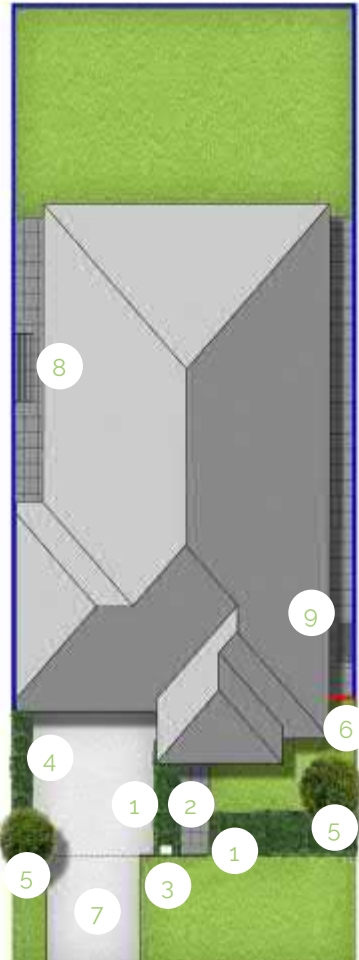

TYPICAL LOT

Example 2

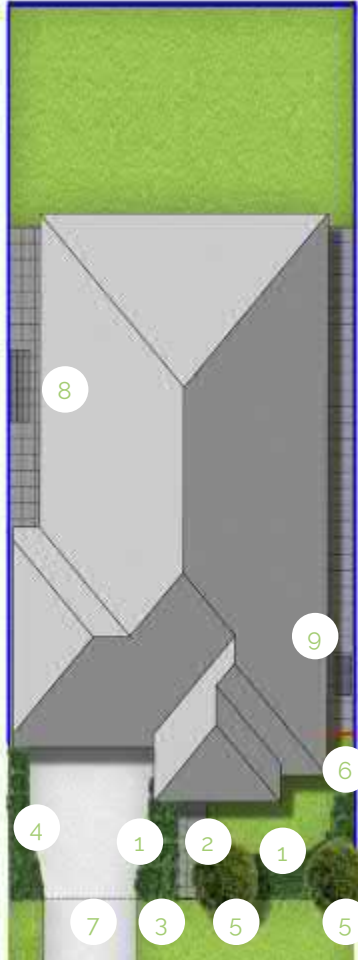

CORNER LOT

Example 1

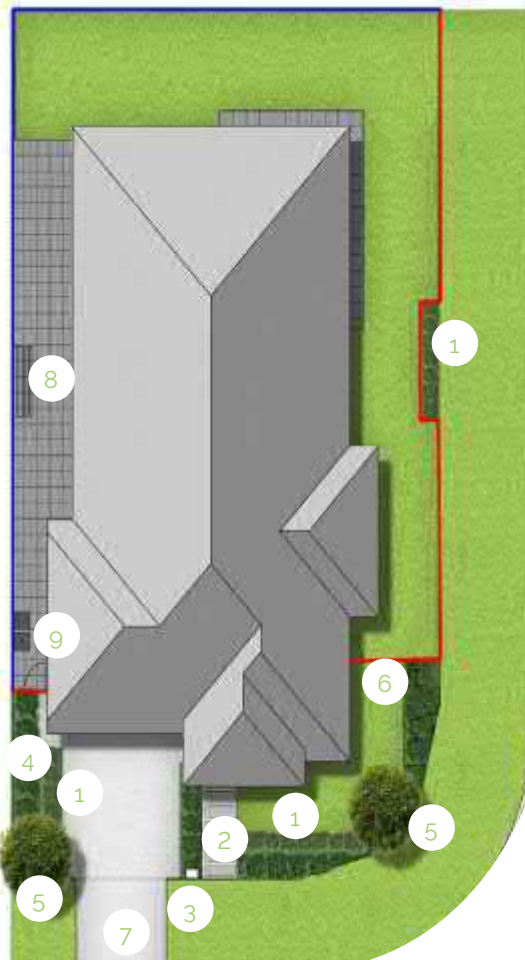

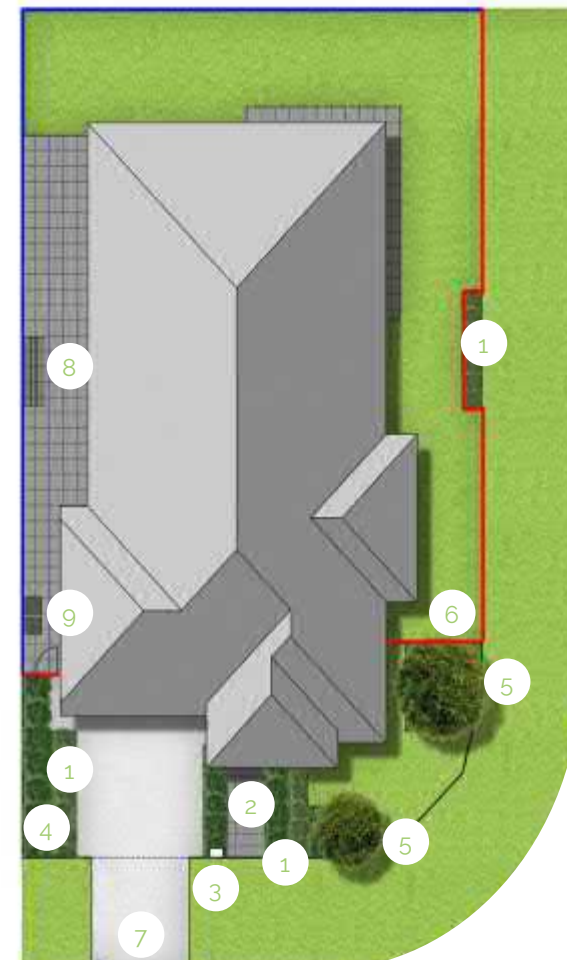

CORNER LOT

Example 2



LEGEND

- | | |
|---|--|
| 1. Shrubs and ground covers | 5. Advanced Tree |
| 2. Entry path constructed from a permanent hard surface | 6. Feature hardwood fence Type A or B |
| 3. Information on letterbox style required for approval | 7. Driveway to LCC standards |
| 4. Hedging plants and groundcovers | 8. Clothesline |
| | 9. Concrete pads for rubbish bin storage |

-  Fence Type 1 or 2
-  Feature Hardwood
-  High Quality Turf

EXAMPLE PLANTING PALETTE: NATIVE



Golden Penda



Native Gardenia



Flowering Gum



Ivory Curl



Tuckeroo



Claret Tops



Swamp Banksia



Midgen Berry



Callistemon 'Little John'



Syzygiun 'Pinnacles'



Doryanthes Excelsa



Westringia Zena



Cushion Bush



Leaf Flower



Miss Muffet



Tussock Grass



Yellow Buttons



Spider Lily



Wild Iris



Native Violet

EXAMPLE PLANTING PALETTE: TROPICAL

FEATURE TREES



Evergreen Frangapani



Macarthur Palm



Dragon tree



Cottonwood Hibiscus



Native Gardenia

TALL SHRUBS



Red Cordyline



Lady Finger Palm



Mauritius Hemp



Summerscent



Sago Palm

SHRUBS



Xanadu



Cordyline 'Pink Diamond'



Bird of Paradise



White Empress



Cardboard Palm

GROUND COVERS



Spider Lily



Kangaroo Vine



Dew Plant



African Lily



Guinea Flower

EXAMPLE PLANTING PALETTE: TRADITIONAL

FEATURE TREES



Native Gardenia



Magnolia 'Teddy Bear'



Pink Trumpet Tree



Rosary Tree



Olive

TALL SHRUBS



Red Robin



Summerscent



Sweet Viburnum



Laurustinus



Lilly Pilly Resilience

SHRUBS



Miss Muffet



New Zealand Christmas Bush



Port Wine Magnolia



Cape Jasmine



Dwarf Indian Hawthorn

GROUND COVERS



Gazania 'Treasure Flower'



Fan Flower



Star Jasmine



Chinese Wisteria



Creeping Fig

PLANT SPECIES INFORMATION: NATIVE

	PLANT SPECIES		MIN. SUPPLY SIZE	LIGHT REQUIREMENTS			WILDLIFE ATTRACTING			MAINTENANCE TIPS & WATER REQUIREMENTS			FLOWERS			
	Common Name	Scientific Name		Full Sun	Part Sun	Full Shade	Birds	Butterfly	Bees/Insects	Prune for Hedge	Drought Tolerant	Moist Soil – Well Mulched	Spring	Summer	Autumn	Winter
Feature Trees	Golden Penda	Xanthostemon chrysanthus	45L	X			X	X	X				X			X
	Native Gardenia	Atractocarpus fitzalanii	45L	X	X		X	X	X	X		X	X			
	Corymbia "Summer Red"	Flowering gum	45L	X	X		X				X			X		
	Ivory Curl	Buckinghamia celsissima	45L	X	X		X	X	X		X					
	Tuckeroo	Cupaniopsis anacardioides	45L	X	X		X				X		X		X	
Tall Shrubs	Claret Tops	Melaleuca 'Claret Tops'	140mm	X							X					
	Swamp Banksia	Banksia robur	140mm	X			X	X	X			X			X	
	Midgen Berry	Austromyrtus dulcis	140mm	X	X		X		X			X	X	X	X	
	Callistemon 'Little John'	Callistemon 'Little John'	140mm	X			X							X	X	
	Pinnacles	Syzygiun 'Pinnacles'	140mm	X	X		X	X	X	X	X	X	X			
Shrubs	Gynea Lily	Doryanthes excelsa	140mm	X			X	X	X	X	X	X	X	X		
	Native Rosemary	Westringia zena	140mm	X	X			X	X	X	X		X			
	Cushion Bush	Leucophyta brownii	140mm	X					X		X			X		
	Leaf Flower	Phyllanthus minutiflora	140mm	X	X		X			X	X					
	Miss Muffet	Pittosporum tobira	140mm		X		X			X	X		X			
Ground Covers	Tussock Grass	Poa labillardierei	140mm	X	X						X		X	X		
	Yellow Buttons	Chrysocephalum apiculatum	140mm	X	X				X				X	X	X	X
	Spider Lily	Hymenocallis littoralis	140mm	X	X				X		X			X		
	Wild Iris	Dietes Grandiflora	140mm	X			X	X			X		X	X		
	Native Voilet	Viola hederacea	140mm		X	X					X	X	X	X	X	

PLANT SPECIES INFORMATION: TROPICAL

	PLANT SPECIES		MIN. SUPPLY SIZE	LIGHT REQUIREMENTS			WILDLIFE ATTRACTING			MAINTENANCE TIPS & WATER REQUIREMENTS			FLOWERS			
	Common Name	Scientific Name		Full Sun	Part Sun	Full Shade	Birds	Butterfly	Bees/Insects	Prune for Hedge	Drought Tolerant	Moist Soil – Well Mulched	Spring	Summer	Autumn	Winter
Feature Trees	Evergreen Frangapani	Plumeria obtusa	45L	X	X		X		X		X		X	X		
	Macarthur Palm	Ptychosperma macarthurii	45L	X	X		X									
	Dragon Tree	Dracaena draco	45L	X	X					X						
	Cottonwood Hibiscus	Hibiscus tiliaceus 'rubra'	45L	X	X		X		X		X		X			
	Native Gardenia	Atractocarpus fitzalanii	45L	X	X		X	X	X	X		X	X			
Tall Shrubs	Red Cordyline	Cordyline rubra	140mm	X	X		X	X			X		X	X		
	Lady Finger Palm	Rhapis excelsa	300mm		X	X										
	Mauritius Hemp	Furcraea foetida 'Veriegata'	140mm	X	X						X	X				
	Summerscent	Radermachera 'Summerscent'	300mm	X	X		X	X	X	X	X			X		
	Sago Palm	Cycas revoluta	300mm		X	X					X					
Shrubs	Xanadu	Philodendron 'Xanadu'	140mm	X	X		X					X				
	Cordyline 'Pink Diamond'	Cordyline fruticosa 'Pink Diamond'	140mm	X	X		X	X			X		X	X		
	Bird of Paradise	Strelitzia reginae	140mm	X							X		X	X	X	X
	White Empress	Alcantarea extensa	140mm	X	X						X	X		X		
	Cardboard Palm	Zamia furfuracea	140mm	X	X						X					
Ground Covers	Spider Lily	Hymenocallis littoralis	140mm	X	X				X		X			X		
	Kangaroo Vine	Cissus antarctica	140mm		X	X						X	X			
	Dew Plant	Aptenia cordifolia	140mm	X			X		X		X		X	X	X	
	African Lily	Agapanthus africanus	140mm		X	X	X		X			X	X	X		
	Guinea Flower	Hibbertia scandens	140mm	X	X				X				X	X		

PLANT SPECIES INFORMATION: TRADITIONAL

	PLANT SPECIES		MIN. SUPPLY SIZE	LIGHT REQUIREMENTS			WILDLIFE ATTRACTING			MAINTENANCE TIPS & WATER REQUIREMENTS			FLOWERS			
	Common Name	Scientific Name		Full Sun	Part Sun	Full Shade	Birds	Butterfly	Bees/Insects	Prune for Hedge	Drought Tolerant	Moist Soil – Well Mulched	Spring	Summer	Autumn	Winter
Feature Trees	Native Gardenia	Atractocarpus fitzalanii	45L	X	X		X	X	X	X		X				
	Magnolia 'Teddy Bear'	Magnolia 'Teddy Bear'	45L		X					X		X	X			
	Pink Trumpet Tree	Tabebuia palmeri	45L	X			X					X	X			
	Rosary Tree	Melia azedarach	45L	X												
	Olive	Olea europa	45L	X							X					
Tall Shrubs	Red Robin	Photinia 'Red Robin'	140mm	X	X		X		X	X	X	X				
	Summerscent	Radermachera 'Summerscent'	300mm	X	X		X	X	X	X	X		X			
	Sweet Viburnum	Viburnum Odoratissimum	140mm	X	X				X	X		X				
	Laurustinus	Viburnum Tinus	140mm	X	X				X	X	X	X				
	Lilly Pilly Resilience	Syzygium 'Resilience'	140mm	X	X		X	X	X	X	X	X				
Shrubs	Miss Muffet	Pittosporum tonira 'Miss Muffet'	140mm		X		X			X	X		X			
	New Zealand Christmas Bush	Metrosideros thomasi	140mm	X			X	X	X	X	X	X	X	X		
	Port Wine Magnolia	Michelia figo	45L	X	X					X	X	X		X		
	Cape Jasmine	Gardenia radicans	140mm	X	X		X	X	X		X		X	X		
	Dwarf Indian Hawthorn	Rhaphiolepis 'Oriental Pearl'	140mm	X					X	X		X		X	X	
Ground Covers	Treasure Flower	Gazania rigens	140mm	X			X	X	X		X		X	X		
	Fan Flower	Scaevola aemula	140mm	X	X				X				X	X	X	
	Star Jasmine	Trachelospermum jasminoides	140mm	X	X				X	X		X	X			
	Chinese Wisteria	Wisteria senensis	140mm	X	X		X	X	X		X		X	X		
	Creeping Fg	Ficus pumila	140mm	X												

Annexure E

Retaining Wall
Fact Sheet & WRB
Retaining Wall
Warranty

Everleigh

Retaining Wall Fact Sheet and Owner Obligations

The Everleigh team have carefully considered and prepared your land during the civil works to ensure the best outcome for your future build. This fact sheet outlines some key ongoing owner obligations to ensure that your retaining walls are well maintained throughout the life of the property.

When designing retaining walls, Mirvac prefer the use of either:

- Boulders, stone or masonry, usually for areas facing the street areas to maximise street appeal, or
- Concrete sleeper panel walls to minimise the impact the structure has on useable land and to reduce maintenance costs because of the robust nature of concrete.

As these retaining walls are contained within private property the land owner owns them and has a responsibility to monitor and maintain the retaining walls. At Everleigh, retaining walls between private lots are located on the common boundary, and hence adjoining landowners share a responsibility to maintain the wall. The following information is provided to assist all homeowners and their builders.

The retaining walls have been designed in accordance with:

- All relevant Australian Standards
- Applicable Logan City Council approvals
- A 5kPa surcharge loading above the retaining wall
- Maximum 1 in 10 back slope above concrete sleeper retaining wall
- Existing site soil properties

In order to avoid adversely affecting the structural integrity of the retaining wall, each land owner has a responsibility to ensure the following (including making builders or tenants aware):

- That works adjacent to the retaining wall structure complies with the design parameters noted above
- That no open excavations, alterations or modifications are permitted within the zone of influence without Engineering assessment. Refer to sketch for definition of 'zone of influence'
- That no structures or trees are installed within the zone of influence (both above and below the retaining wall) without Engineering assessment
- Water is not permitted to pond within the zone of influence above or below the wall
- Any site works within any individual allotment must not disrupt the wall drainage including limiting discharge from the retaining wall

- The retaining walls have been constructed with a subsoil drain located on the common boundary between you and your neighbour's property. A non-slotted sub-soil drain outlet has been installed with a marker post labelled 'Retaining Wall Subsoil Outlet' on relevant lots. Your builder should connect this outlet to the yard / roofwater drainage system they install as part of their house contract works. Connecting this drain will mitigate the chance of water ponding in your backyard. Refer to sketch of 'typical retaining wall subsoil outlet to allotments' for further detail.
- No machinery is to be used above the retaining wall where it would result in a load more than the 5kPa limit noted above as this may cause deformation of the wall components
- The wall height is not to be raised by any method, including bolting on or constructing an additional retaining wall above, without obtaining an engineering assessment of the effects on the wall

Installation of a solid 1.8m boundary fence on or adjacent to the wall (depending on boundary location and/or agreement with neighbour) is acceptable provided the consideration given to the items raised above. As with all fences, design and construction of the fence is the owner's responsibility.



Zone of Influence

The following information is provided as a general guide. If you are unsure you should consult with a suitably qualified engineer to confirm the actual extent of the zone of influence.

For example, if the wall height (H) is 1.6m then:

For the Lower Lot the Zone of Influence extends from the base of the wall for $H \times 1.25$ or $1.6\text{m} \times 1.25 = 2\text{m}$

For the Upper Lot the Zone of Influence extends from the base of the wall for $H \times 1.25$ or $1.6\text{m} \times 1.25 = 2\text{m}$

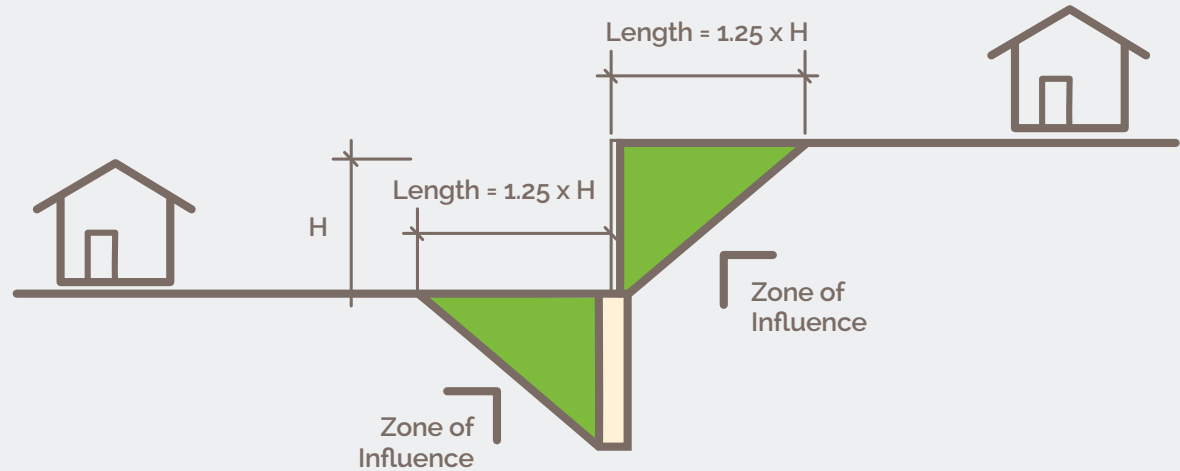

Typical Retaining Wall Subsoil Outlet on Relevant Low Side Allotments

Installed in the rear corner of relevant allotments located on the low side of a retaining wall.

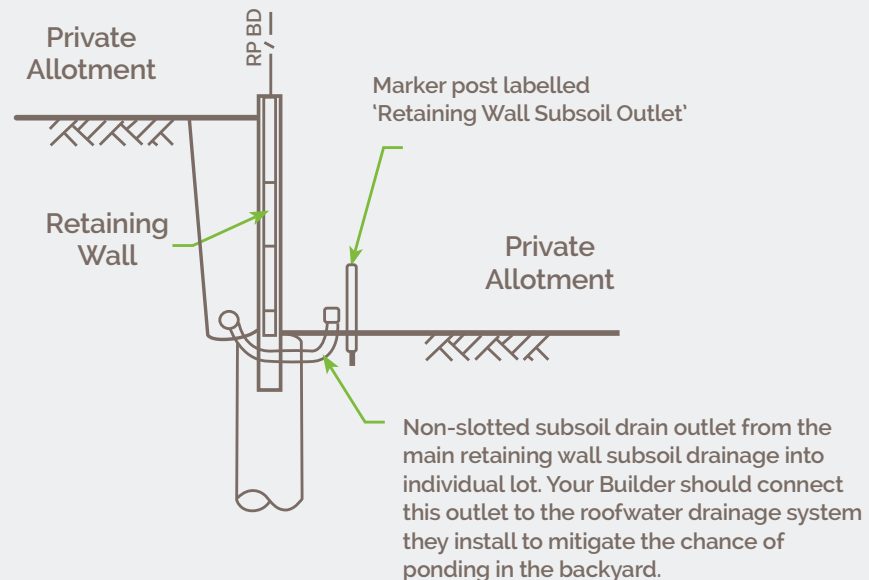

Visit the sales office open daily 10am – 5pm
3 Guroman Drive, Greenbank
Call 07 3859 5960 or visit everleigh.mirvac.com

Product Warranty

TO: Warranty Holder

Retaining Wall Warranty

WRB Group Holdings Pty Ltd (QBCC Licence No. 15065209) ABN 47 620 599 377 (WRB) warrants that if the structural integrity of the retaining wall supplied and installed by WRB for the Project, fails as a direct result of it not having been reasonably fit for its purpose at the time of its installation, WRB will for the term of 15 years commencing from the Installation Date, repair the retaining wall or compensate the Warranty Holder in accordance with the following terms and conditions:

Subject Retaining Walls

This warranty is provided only for retaining walls constructed by WRB in accordance with records maintained by WRB. Details for retaining walls constructed by WRB on a specific lot can be obtained from WRB on request by a Warranty Holder. The retaining wall warranty does not extend to cover any liability, loss or damage, consequential or otherwise however suffered or incurred as a direct or indirect result of the supply or installation of the retaining wall by WRB. This product warranty is in addition to other rights and remedies under the consumer law (see additional benefit).

Claim

You must make a claim under this product warranty within 3 months of becoming aware, or when you should reasonably have become aware, of the failure in the structural integrity of the retaining wall by providing WRB with written details of:

- (a) the failure sufficient to enable WRB to assess the claim;
- (b) the name of the estate, lot number and street address where the failure occurred; and
- (c) your name, street address, email address, daytime telephone number and interest in the land,

by email to admin@wrbconstruction.com.au or post to PO Box 4411, Gumdale QLD 4154.

Assessment

WRB will assess your claim within a reasonable time, and give you written notice of WRB's assessment of your claim.

If in assessing your claim, WRB requires you to make the retaining wall available for inspection, you will make it available for inspection by WRB within a reasonable time.



If WRB assesses that failure in the structural integrity of the retaining wall has occurred as a direct result of it not having been reasonably fit for its intended purpose at the time of its installation, WRB will take one of the following actions (the election of which will be made by WRB in WRB's absolute discretion) within 28 days after giving you written notice of WRB's assessment of your claim:

- (a) repair the retaining wall; or
- (b) compensate you for the reasonable cost to repair the retaining wall.

Exclusions & Limitations

WRB will not have any liability to you under this product warranty if:

- (a) the retaining wall is altered, modified or damaged by any person, thing or weather event outside of the Design Scope after the Installation Date.
- (b) the retaining wall is not reasonably maintained, and failure of the retaining wall is accelerated as a result. To avoid any doubt, the Warranty Holder's obligations include but are not limited to ensuring that:
 - no open excavations, alterations or modifications are permitted within the zone of influence without Engineering assessment in writing.
 - no structures or trees are installed within the zone of influence (both above and below the retaining wall) without Engineering assessment in writing
 - water is not permitted to pond within the zone of influence above or below the wall
 - any site works within any individual allotment must not disrupt the wall drainage including limiting discharge from the retaining wall
 - no machinery is to be used above the retaining wall where it would result in a load more than the 5kPa as this may cause deformation of the wall components
 - the wall height is not to be raised by any method, including bolting on or constructing an additional retaining wall above, without obtaining an Engineering assessment of the effects on the wall (noting that installation of a solid 1.8m boundary fence on or adjacent to the wall (depending on boundary location and/or agreement with neighbour) is acceptable provided consideration is given to the items raised above).
- (c) you are not the Warranty Holder;
- (d) you fail to make a claim under this product warranty strictly within 3 months of becoming aware, or when you should reasonably have become aware, of the failure in the structural integrity of the retaining wall.

Transfer of warranty



The benefit of this warranty may be transferred to a new land owner if the property is sold subject to:

- The Warranty Holder making a written request to WRB; and
- WRB agreeing in writing to transfer the benefit of the warranty (acting reasonably).

Additional Benefit

The benefits provided to you under this product warranty are in addition to other rights and remedies, including any right or remedy under the Australian Consumer Law, you may have at law, in equity or under statute.

Definitions

Developer means Mirvac Queensland Pty Limited

Warranty Holder means the lawful owner of the land where the owner:

- is the Developer;
- is the first transferee when the Developer transfers ownership of the land (subject to the first transferee registering the warranty with WRB within 3 months of transfer of the land); or
- has WRB's written confirmation that the warranty has been validly transferred to them.

Installation Date means the date on which the relevant Form 16 is signed.

Zone of Influence means the area adjacent to the retaining wall within which any changes to ground conditions may have an impact on the performance of the retaining wall.

Design Scope means the codes which are outlined in the Form 15 to identify how the retaining wall has been designed.

Project means the Everleigh subdivision development undertaken by the Developer at Teviot Road, Greenbank in the State of Queensland.



Everleigh

Residential Design
Standards and Guidelines
Precinct 9.6

REVISIONS SCHEDULE

REVISION	DATE	CHANGES MADE
A	18.04.2023	First Copy
B	15.11.2023	Amended